

22-34GHz, 2-Way Power Divider/Combiner

GaAs Monolithic Microwave IC in SMD leadless package

Description

The CHW4312-QKA is a 2-way 0° Power splitter/Combiner designed for wideband operation from 22 to 34GHz. It supports many applications including phase array radars, 5G applications as well as satellite communications and Test & Measurements. The circuit is manufactured on GaAs passive technology dedicated for high performance. It is supplied in RoHS compliant 2x2mm SMD package.



Main Features

- Broadband performances: 22-34GHz
- Normalized Insertion Loss: 0.75dB
- Isolation in the range of 20dB
- Good amplitude unbalance: 0dB
- Very good phase unbalance: Typical 3°
- 8L DFN2x2
- MSL1

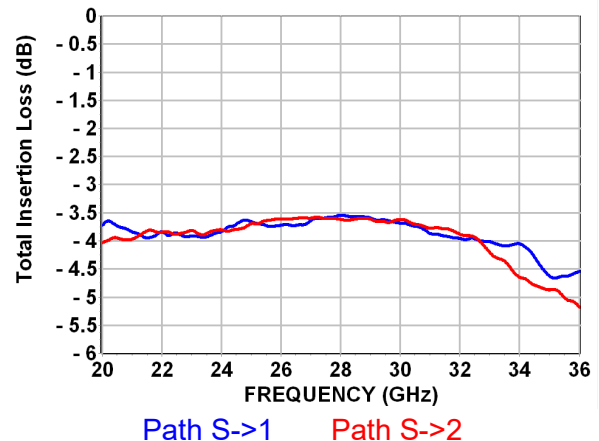

Main Electrical Characteristics

Tamb.= +25°C

Symbol	Parameter	Min	Typ	Max	Unit
Freq	Frequency range	22		34	GHz
IL	Insertion Loss (above 3dB)		0.75		dB
Isolation	Isolation		20		dB
AU	Amplitude Unbalance		0		dB
PU	Phase Unbalance		3		°

CHW4312-QKA 22-34GHz, 2-Way Power Divider/Combiner

Specifications

Tamb.= +25°C,

Symbol	Parameter	Min	Typ	Max	Unit
Freq	Frequency range	22		34	GHz
IL	Insertion Loss (above 3 dB)		0.75		dB
Isolation	Isolation		20		dB
AU	Amplitude Unbalance		0		dB
PU	Phase Unbalance		3		°
RL_Sum	Return Loss (Port Sum)		15		dB
RL_12	Return Loss (Port 1-2)		15		dB
PH_Sum	Power Handling (Port Sum) when the part is used as Power divider			30	dBm
PH_12	Power Handling (on Port1 and on Port 2) when the part is used as Combiner			27	dBm

These values are representative of on board measurements as defined on the drawing in paragraph " Evaluation board for measurements accuracy" using RF probes

Absolute Maximum Ratings ⁽¹⁾T_{amb.} = +25°C

Symbol	Parameter	Values	Unit
Pin_max_Sum	Maximum input power (AMR) on Sum port when the part is used as Power divider	33	dBm
Pin_max_12	Maximum input power (AMR) on Port 1 and on Port 2 when the part is used as Combiner	30	dBm

Temperature Range

T _a	Operating temperature range	-40 to +85	°C
T _{stg}	Storage temperature range	-55 to +150	°C

CHW4312-QKA 22-34GHz, 2-Way Power Divider/Combiner

Typical Package Sij parameters

Tamb.= +25°C.

The reference planes used for Sij measurements presented in this document are located at 0.8mm offset from the package edges.

Path : S->2

Freq (GHz)	S11 (dB)	PhS11 (°)	S12 (dB)	PhS12 (°)	S21 (dB)	PhS21 (°)	S22 (dB)	PhS22 (°)
20,00	-7,70	61,05	-4,01	-35,86	-4,03	61,40	-10,66	-48,36
20,50	-7,84	53,62	-3,95	-42,19	-3,96	53,92	-10,93	-53,22
21,00	-8,52	47,14	-3,95	-54,07	-3,97	47,49	-11,30	-58,77
21,50	-8,75	39,15	-3,83	-57,01	-3,84	39,30	-11,68	-63,72
22,00	-8,78	31,43	-3,83	-67,20	-3,85	31,83	-11,96	-71,02
22,50	-9,47	23,81	-3,88	-78,52	-3,89	23,92	-12,36	-77,09
23,00	-9,86	15,84	-3,79	-81,76	-3,81	16,17	-13,19	-82,84
23,50	-10,42	8,90	-3,85	-101,18	-3,86	9,04	-13,92	-86,90
24,00	-11,23	0,53	-3,78	-106,48	-3,80	0,84	-14,52	-94,74
24,50	-12,97	-6,56	-3,74	-121,84	-3,75	-6,49	-15,61	-100,71
25,00	-14,18	-14,78	-3,68	-133,87	-3,69	-14,60	-16,28	-106,21
25,50	-15,88	-22,84	-3,62	-134,38	-3,63	-22,84	-17,58	-114,36
26,00	-16,71	-30,96	-3,59	-152,09	-3,61	-30,81	-19,03	-116,45
26,50	-17,82	-39,60	-3,60	-157,69	-3,61	-39,31	-19,66	-124,16
27,00	-20,16	-47,37	-3,58	171,44	-3,59	-46,86	-22,70	-137,68
27,50	-19,05	-56,24	-3,60	155,41	-3,61	-55,71	-25,00	-140,64
28,00	-26,11	-64,29	-3,61	104,17	-3,62	-63,64	-27,87	-154,89
28,50	-21,98	-72,84	-3,59	83,69	-3,60	-72,15	-35,93	-149,78
29,00	-21,75	-81,46	-3,60	15,42	-3,61	-80,84	-43,54	-107,83
29,50	-17,50	-89,81	-3,67	-4,52	-3,67	-89,10	-36,45	30,51
30,00	-16,88	-98,25	-3,61	-30,53	-3,62	-97,59	-27,29	17,39
30,50	-14,00	-107,59	-3,71	-55,55	-3,72	-106,86	-24,82	-5,24
31,00	-13,47	-115,91	-3,76	-71,10	-3,77	-115,16	-21,43	-4,02
31,50	-12,66	-125,03	-3,82	-83,72	-3,82	-124,28	-18,84	-20,04
32,00	-12,47	-134,20	-3,88	-82,77	-3,88	-133,46	-17,59	-24,72
32,50	-11,91	-143,62	-3,96	-89,66	-3,97	-142,87	-14,78	-37,67
33,00	-9,40	-152,80	-4,20	-95,76	-4,21	-152,08	-13,96	-51,86
33,50	-8,13	-161,32	-4,43	-108,09	-4,44	-160,65	-12,78	-59,65
34,00	-7,10	-169,59	-4,64	-118,45	-4,65	-168,88	-11,54	-70,67
34,50	-6,55	-177,89	-4,77	-128,44	-4,79	-177,27	-10,39	-80,85
35,00	-6,29	173,58	-4,86	-135,33	-4,87	174,19	-9,64	-88,55
35,50	-6,02	163,60	-4,94	-139,01	-4,96	164,21	-8,77	-98,75
36,00	-5,12	153,64	-5,17	-140,99	-5,18	154,31	-8,23	-108,10

Typical Board Measurements

Tamb.= +25°C (see "Evaluation board for measurements accuracy" using RF probes)

Total Insertion Loss versus Frequency

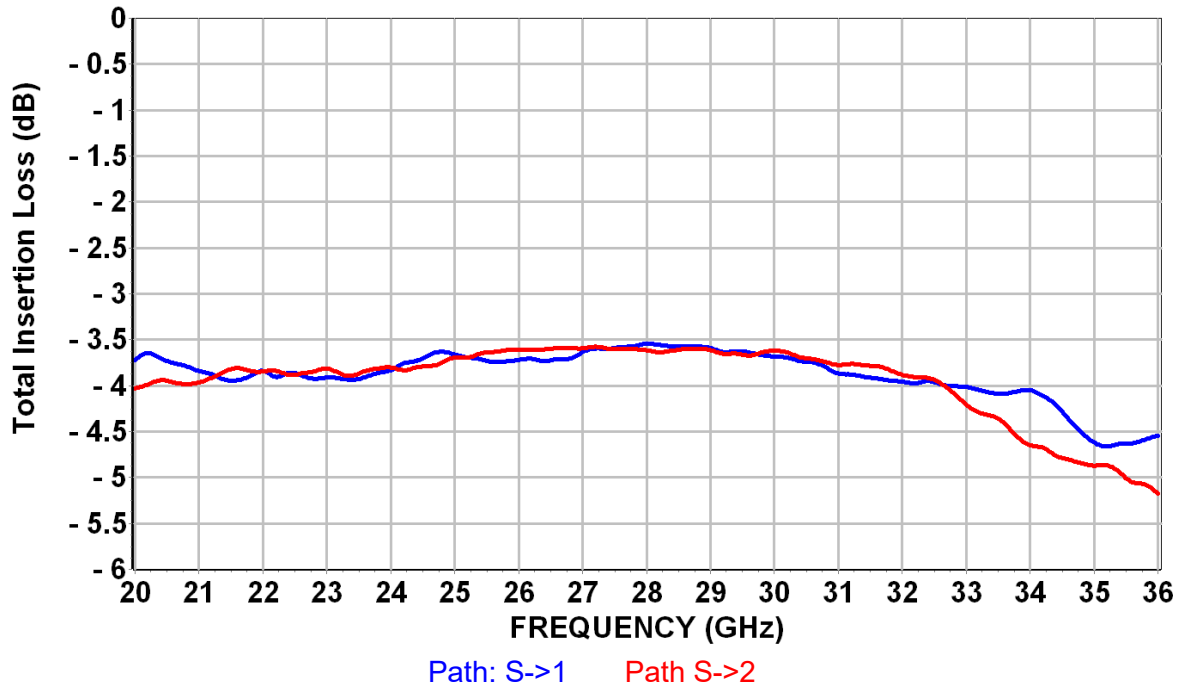

Isolation versus Frequency

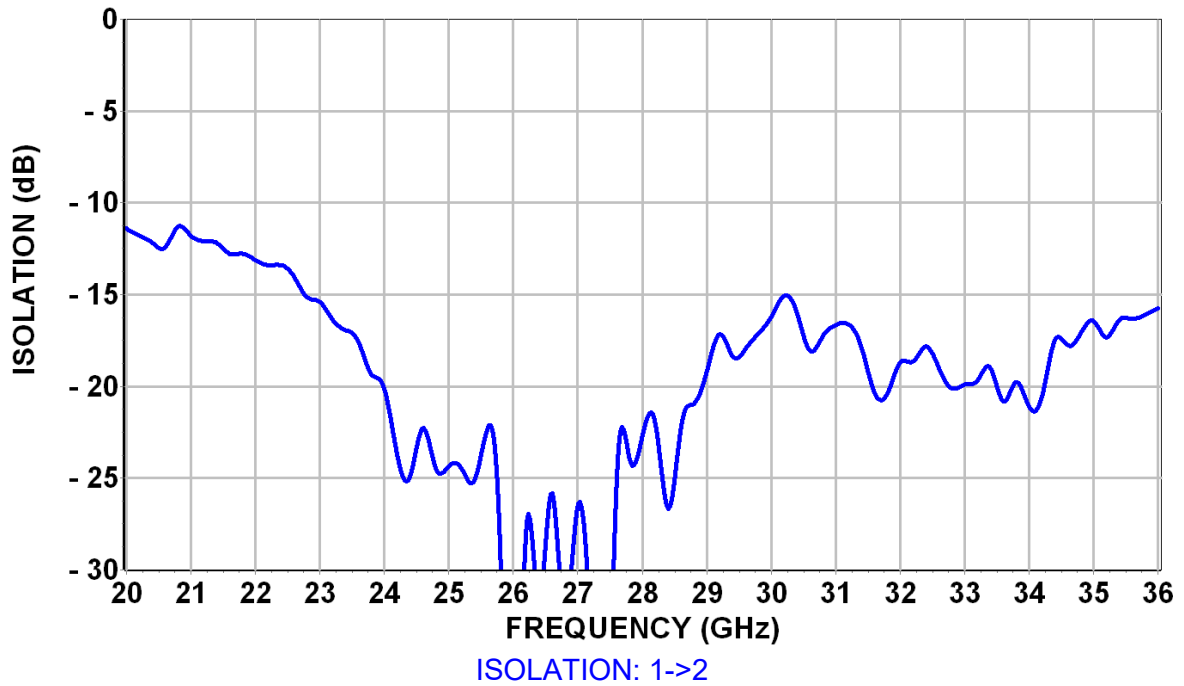

Typical Board Measurements

Tamb.= +25°C (see "Evaluation board for measurements accuracy" using RF probes)

Amplitude Unbalance versus Frequency

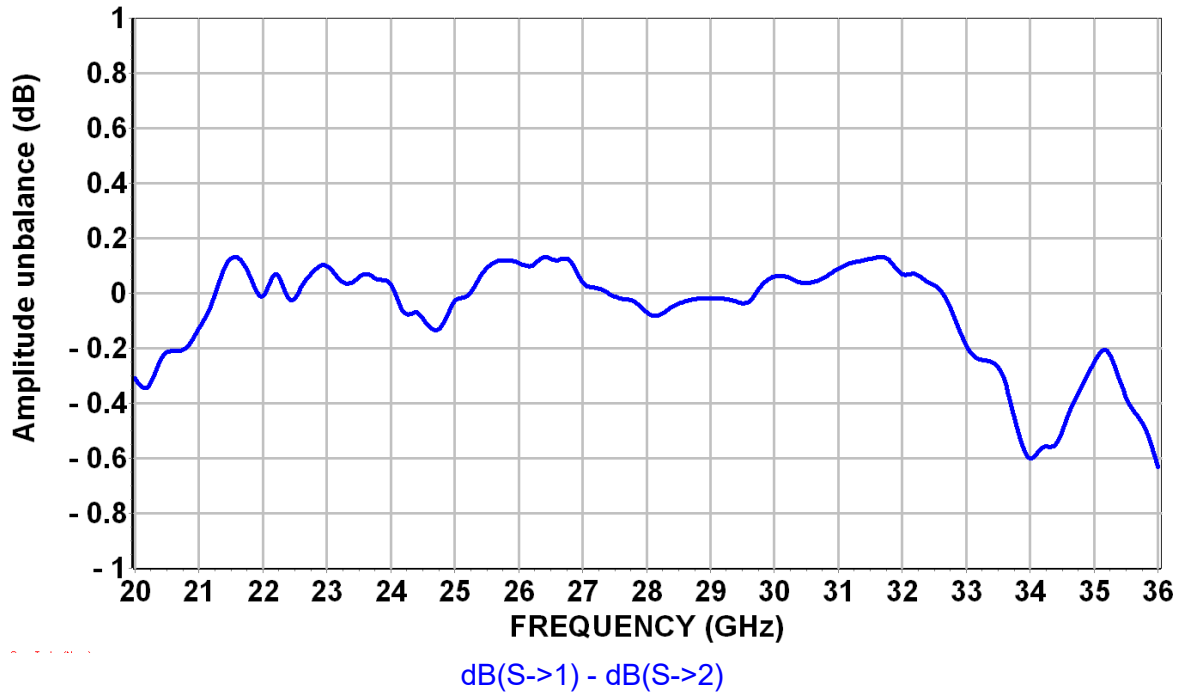

Phase Unbalance versus Frequency

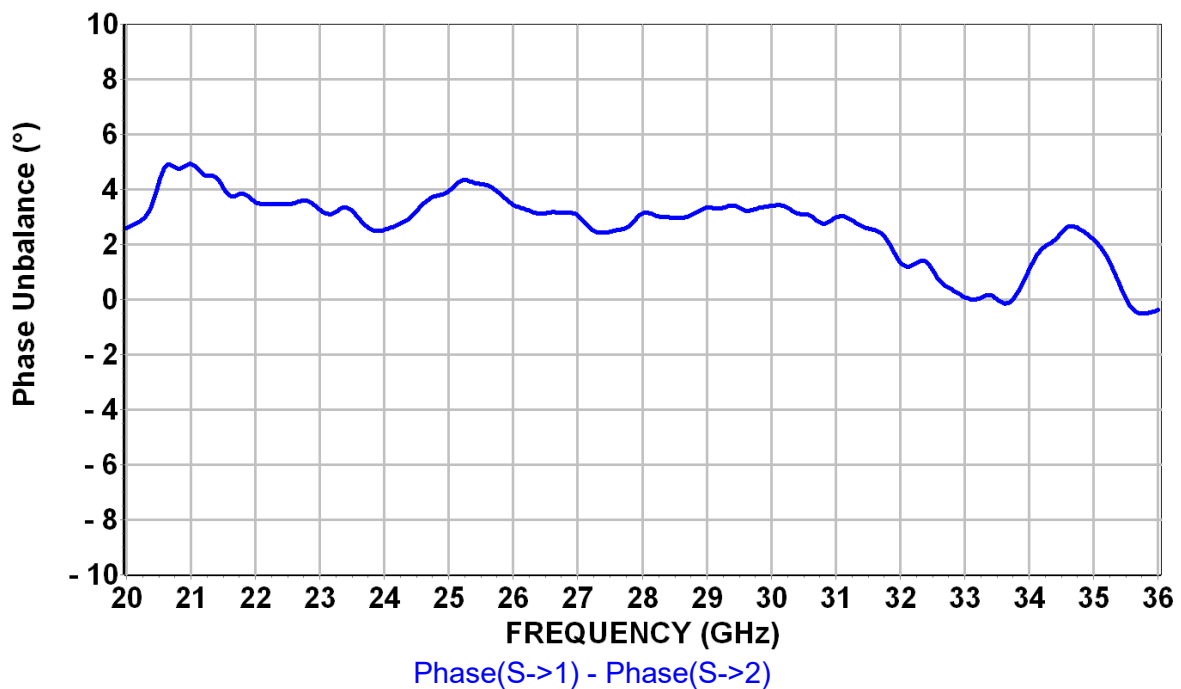

Typical Board Measurements

Tamb.= +25°C (see "Evaluation board for measurements accuracy" using RF probes)

Input Return Loss (SUM) versus Frequency

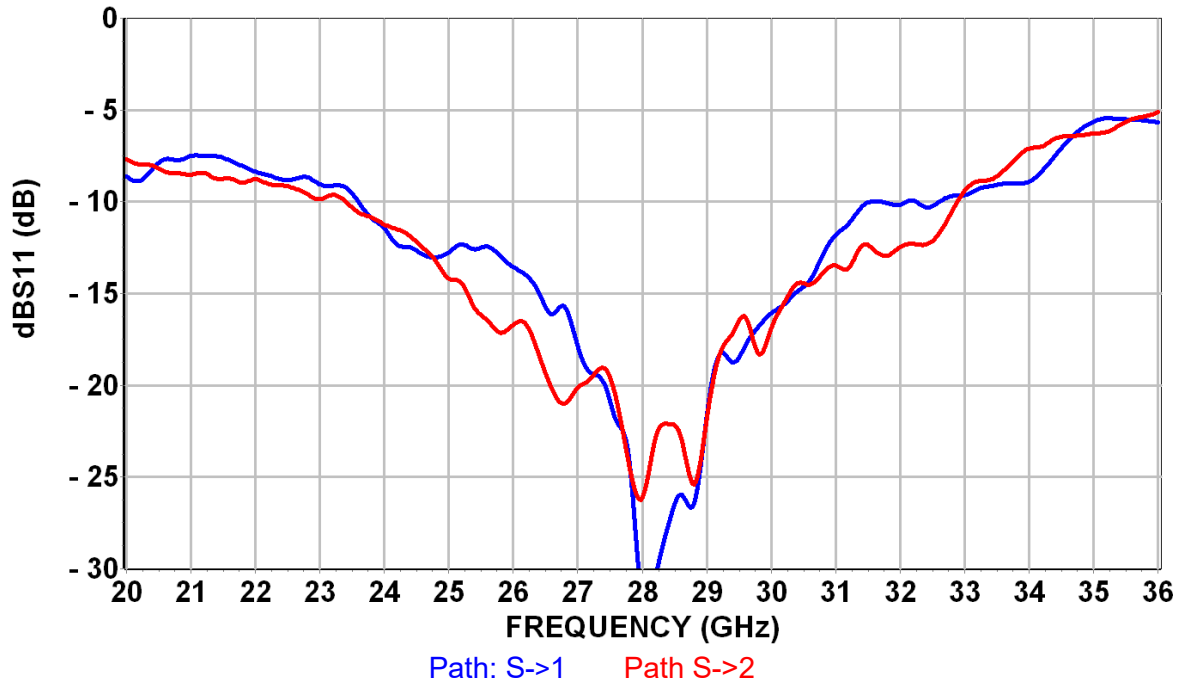

Output Return Loss (Port 1,2) versus Frequency

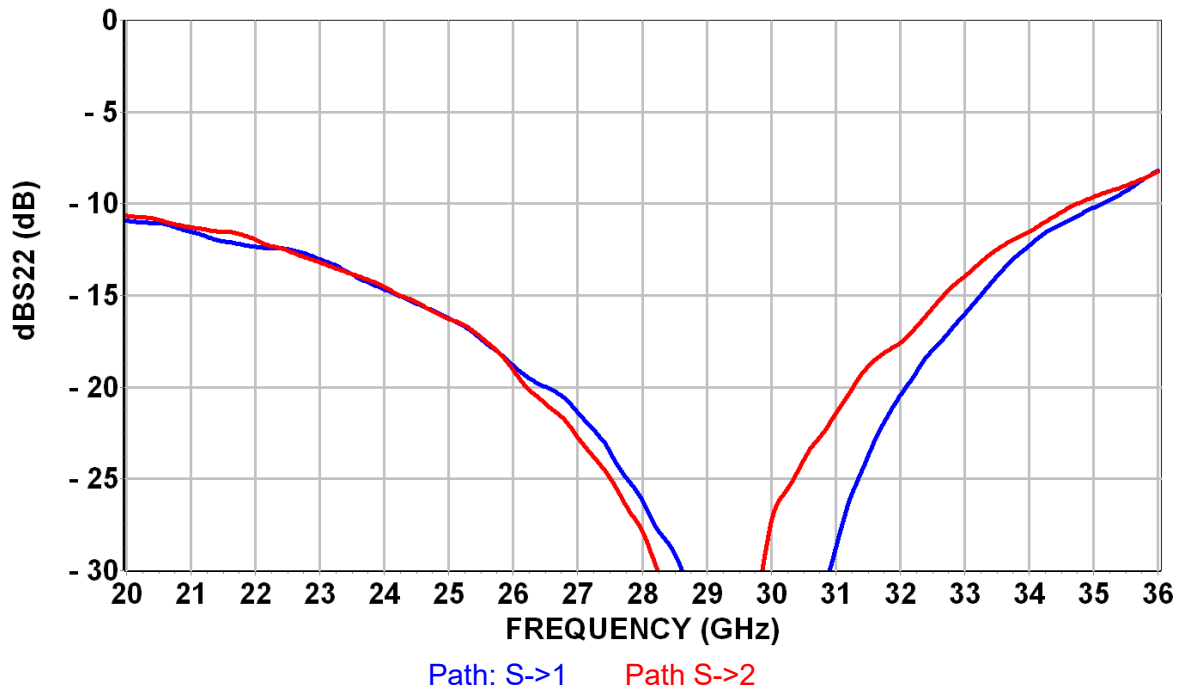

CHW4312-QKA 22-34GHz, 2-Way Power Divider/Combiner

Simplified Schematic for the 2-Way 0° 50 ohms Power Divider / Combiner

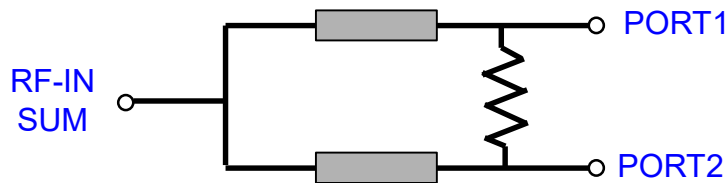

The SUM PORT has been noted S in the previous pages of this document.

Path S->1 is entering the part on the SUM port and exiting thru the PORT1 (North East access of the package)

Path S->2 is entering the part on the SUM port and exiting thru the PORT2 (South East access of the package)

Package outline (1)

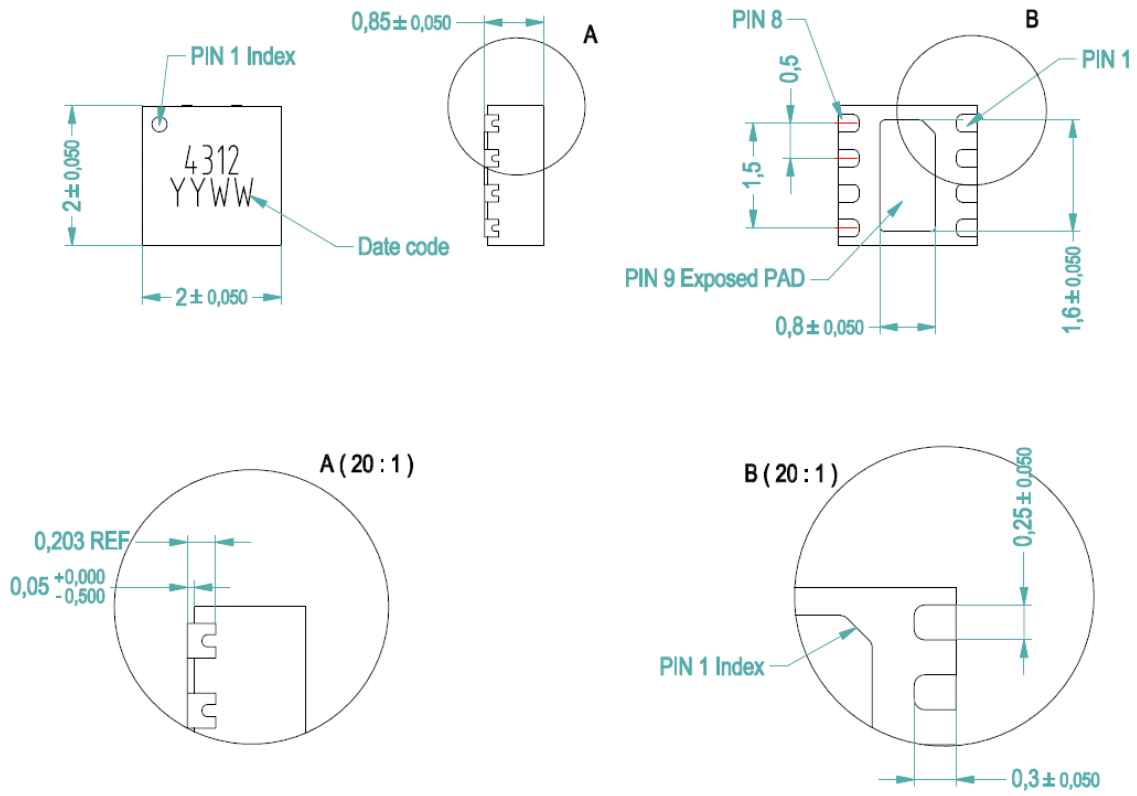

Lead Free	(Green)	1- NC	5- PORT2
Units :	mm	2- GND	6- GND
From the standard :	JEDEC MO-229	3- IN-SUM	7- GND
	(VCCD)	4- NC	8- PORT1
	9- GND		

(1) The package outline drawing included to this data-sheet is given for indication.

(2) It is strongly recommended to ground all pins marked "GND" through the PCB board. Ensure that the PCB board is designed to provide the best possible ground to the package.

Evaluation board for measurements accuracy

Losses due to board are partly de-embedded: the reference planes used for S_{ij} measurements presented previously in this document are located at 0.8mm offset from the package edges. Reference planes are showed in red on the drawing.

Note: The given S_{ij} parameters incorporate the land pattern of the evaluation motherboard.

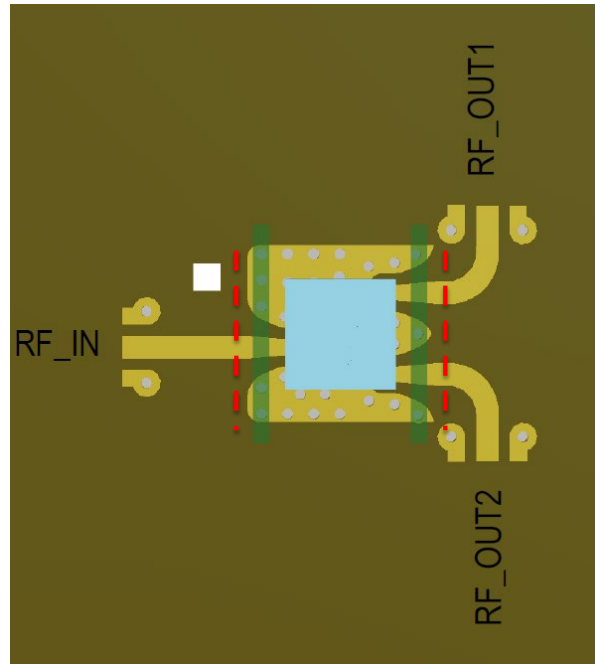

Package Information

Parameter	Value
Package body material	RoHS-compliant
	Low stress Injection Molded Plastic
Lead finish	Ni-Pd-Au

Evaluation board for temperature characterization

- Compatible with the proposed footprint.
- Based on typically Ro4003 / 8mils or equivalent.
- Using a micro-strip to coplanar transition to access the package.
- Recommended for the implementation of this product on a module board.
- See application note AN0017 for details.

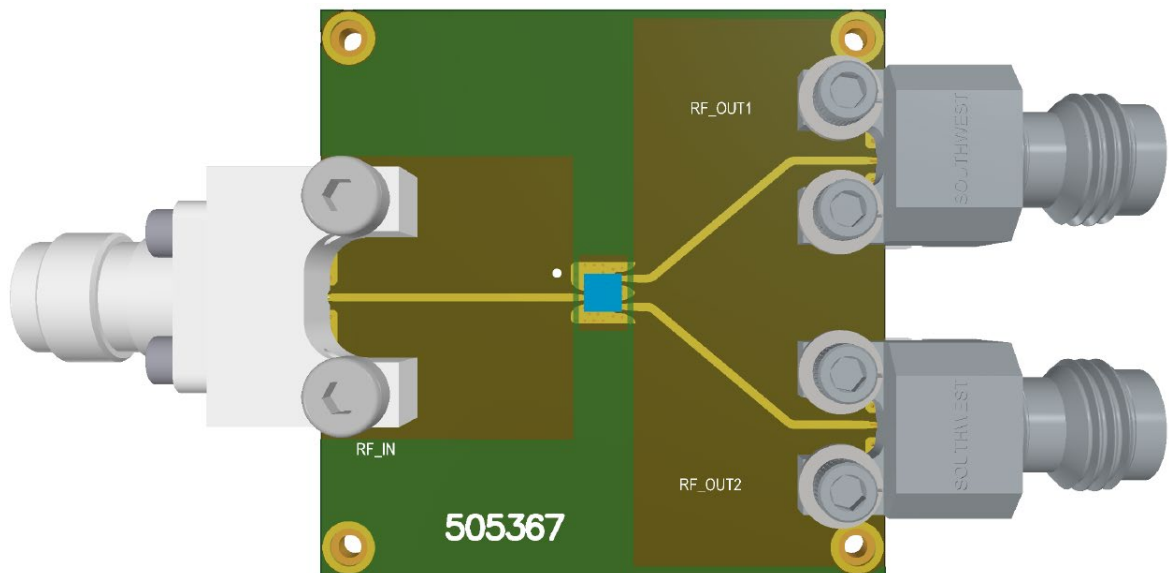

Note: All board measurements are performed using shielded cables to ensure safe operation.

CHW4312-QKA 22-34GHz, 2-Way Power Divider/Combiner

Recommended package footprint

Package foot print recommendations could be provided on request.

SMD mounting procedure

For the mounting process standard techniques involving solder paste and a suitable reflow process can be used. For further details, see application note AN0017 at <https://www.ums-rf.com>.

Recommended environmental management

UMS products are compliant with the regulation in particular with the directives RoHS N°2011/65 and REACH N°1907/2006. More environmental data are available in the application note AN0019 also available at <https://www.ums-rf.com>.

Recommended ESD management

Refer to the application note AN0020 available at <https://www.ums-rf.com> for ESD sensitivity and handling recommendations for the UMS package products.

Ordering Information

DFN 2x2 package:

CHW4312-QKA/XY
Tape & Reel: XY = 21

Information furnished is believed to be accurate and reliable. However **United Monolithic Semiconductors S.A.S.** assumes no responsibility for the consequences of use of such information nor for any infringement of patents or other rights of third parties which may result from its use. No license is granted by implication or otherwise under any patent or patent rights of **United Monolithic Semiconductors S.A.S.** Specifications mentioned in this publication are subject to change without notice. This publication supersedes and replaces all information previously supplied. **United Monolithic Semiconductors S.A.S.** products are not authorised for use as critical components in life support devices or systems without express written approval from **United Monolithic Semiconductors S.A.S.**