

S-Band 60W GaN High Power Amplifier

GaN HEMT on SiC and GaAs Monolithic Microwave Matching Circuits in SMD leadless package

Description

The CHZ9012-QFA is an S-Band Quasi-MMIC High Power Amplifier based on GaN power bar and GaAs input and output matching circuits.

It is fabricated using UMS 0.25µm GaN on SiC and GaAs MMIC High Power UMS Passive technologies.

The CHZ9012-QFA is fully matched on 50 Ohms. It can be used following several operating conditions to meet system requirements. This product is dedicated to a wide range of applications, from military to commercial radar systems.

The CHZ9012-QFA is proposed in low cost plastic package providing low parasitic and low thermal resistance.

The CHZ9012-QFA is supplied in RoHS compliant SMD package.

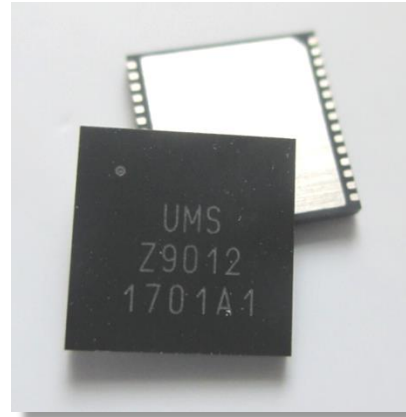

30 leads DFN package-8x8 mm²

Main Features

- Frequency Range: 2.7-3.4GHz
- Pulsed operating mode
- High power: > 60W
- High Efficiency: > 50%
- DC bias: Vd up to 30Volt
- Low cost package: 30L-DFN 8x8mm²
- Compatible UMS Driver: CHZ8012-QJA

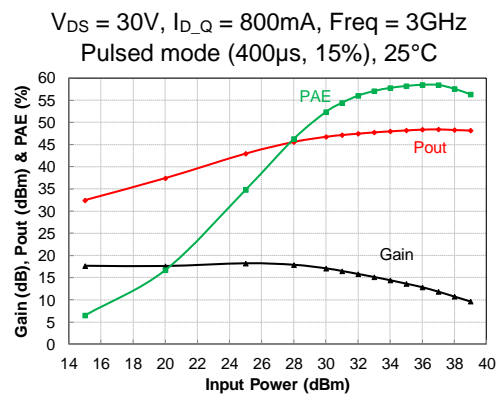

Performances on S-band Evaluation Board

Main Electrical Characteristics

T_{case}= +25°C, Pulsed mode, V_{DS}=30V, I_{D-Q}=800mA

Symbol	Parameter	Min	Typ	Max	Unit
Freq	Frequency range	2.7		3.4	GHz
Gain	Linear Gain		16		dB
Pout	Saturated Output Power		65		W
PAE	Max Power Added Efficiency		52		%

Recommended Operating Ratings

$T_{case} = +25^{\circ}C$

Symbol	Parameter	Min	Typ	Max	Unit	Conditions
V_{DS}	Drain to Source Voltage			30	V	
V_{GS}	Gate to Source Voltage		-3.7		V	$V_{DS}=30V$, $I_{D_Q}=0.8A$
I_{D_Q}	Quiescent Drain Current		0.8	1.1 ⁽¹⁾	A	$V_{DS} =30V$
I_{D_MAX}	Drain Current		4	⁽¹⁾	A	$V_{DS}=30V$, compressed mode
I_{G_MAX}	Gate Current in forward mode		0	80	mA	DC or Compressed mode
Pw	Pulse width		0.4	1	ms	Pulse width
DC	Duty Cycle		10	15	%	Duty Cycle
T_{case}	Case Operating Temperature	-30		100	$^{\circ}C$	⁽¹⁾
T_{j_MAX}	Junction temperature			200	$^{\circ}C$	⁽¹⁾

⁽¹⁾ Power dissipation must be considered.

Electrical Characteristics

$T_{case} = +25^{\circ}C$, RF Pulsed mode (400 μ s / 15%), Class AB ($I_{D_Q}=800mA$)

Symbol	Parameter	Min	Typ	Max	Unit
Fop	Operating frequency range	2.7		3.4	GHz
Gain	Small Signal Gain		15		dB
P_{sat}	Saturated Output Power		48		dBm
PAE	Power Added Efficiency		55		%
G_{PAE_max}	Associated gain at maximum PAE		12		
V_{DS}	Biasing Drain Voltage		30		V
V_{GS}	Biasing Gate Voltage		-3.7		V
I_{D_Q}	Quiescent drain current		800		mA
RI_{in}	Input Return Loss		-11		dB
RI_{out}	Output Return Loss		-6.5		dB

These values are representative of on board measurements as defined on the drawing in paragraph "Evaluation Board".

Electrical Characteristics

$T_{case} = +25^{\circ}\text{C}$, RF Pulsed mode (400 μs / 15%), Class B ($I_{D_Q} \sim 0\text{mA}$)

Symbol	Parameter	Min	Typ	Max	Unit
F _{op}	Operating frequency range	2.8		3.4	GHz
P _{sat}	Saturated Output Power		48		dBm
PAE	Power Added Efficiency		55		%
G _{PAE_max}	Associated gain at maximum PAE		10		
V _{DS}	Biasing Drain Voltage		30		V
V _{GS}	Biasing Gate Voltage		-4,8		V
RI _{in}	Input Return Loss @ maximum PAE		-11		dB

These values are representative of on board measurements as defined on the drawing in paragraph "Evaluation Board".

Absolute Maximum Ratings ⁽¹⁾ ⁽²⁾ ⁽³⁾

Symbol	Parameter	Rating	Unit	Note
V _{DS}	Drain-Source Biasing Voltage	-0.5, +35	V	
V _{GS_Q}	Gate-Source Biasing Voltage	-15, -1	V	(4) (5)
I _{G_MAX}	Maximum Gate Current (forward mode; 25°C)	175	mA	(4)
I _{G_MIN}	Minimum Gate Current (reverse mode; 25°C)	-11	mA	
P _{IN}	Maximum Input Power	42	dBm	(4) (5)
P _w	Pulse width	3	ms	(4)
DC	Duty Cycle	30	%	(4)
T _j	Junction temperature	230	°C	
T _{STG}	Storage Temperature	-55 to +125	°C	
T _{Case}	Case Operating Temperature	-40 to +110	°C	(4)

⁽¹⁾ Operation of this device above anyone of these parameters may cause permanent damage.

⁽²⁾ Duration < 1s.

⁽³⁾ The given values must not be exceeded at the same time even momentarily for any parameter, since each parameter is independent from each other. Otherwise deterioration or destruction of the device may take place.

⁽⁴⁾ Max junction temperature must be considered

⁽⁵⁾ Limited by I_{G_MAX} & I_{G_MIN} values.

Biasing procedure

1. Bias power bar gate voltage at V_{GS} close to V_{pinch-off} (Typically: V_{GS} ≈ -5V)
2. Apply V_{DS} bias voltage (Typically: V_{DS} = 30V)
3. Increase V_{GS} up to quiescent bias drain current I_{D_Q}
The quiescent current steady state must be carefully controlled as it is influenced by the operating mode, the temperature and the overall thermal resistance.
A drain current control is recommended on the biasing network.

Device thermal performances

The thermal performances of the device are based on UMS rules to evaluate the junction temperature (T_j). This temperature is defined as the peak temperature in the channel area.

This same procedure is the basis for junction temperature evaluation of the samples used to derive the Median lifetime and activation energy for the particular technology on which the CHZ9012-QFA is fabricated (GaN Power PHEMT 0.25 μ m).

The temperature T_{case} is defined as the package back side temperature.

The thermal resistance (R_{th}) is considered in pulsed mode as given in the table. The device assembly must be adapted to the operating mode, especially for SMD components which are very dependent on PCB characteristics. Thermal analysis is recommended. More information is available on request.

Parameters	Symbol	Conditions (Package)	Value	Unit
Typical Thermal Resistance (junction-case)	R_{th}	$T_{case} = 95^{\circ}C$ $P_{in}=39dBm$ Total dissipated power=50W	0.86 (global device)	$^{\circ}C/W$
Junction Temperature	T_j	(Saturated operating mode) Pulsed mode: 400 μ s/15%	138	$^{\circ}C$

Median Life Time versus Junction Temperature

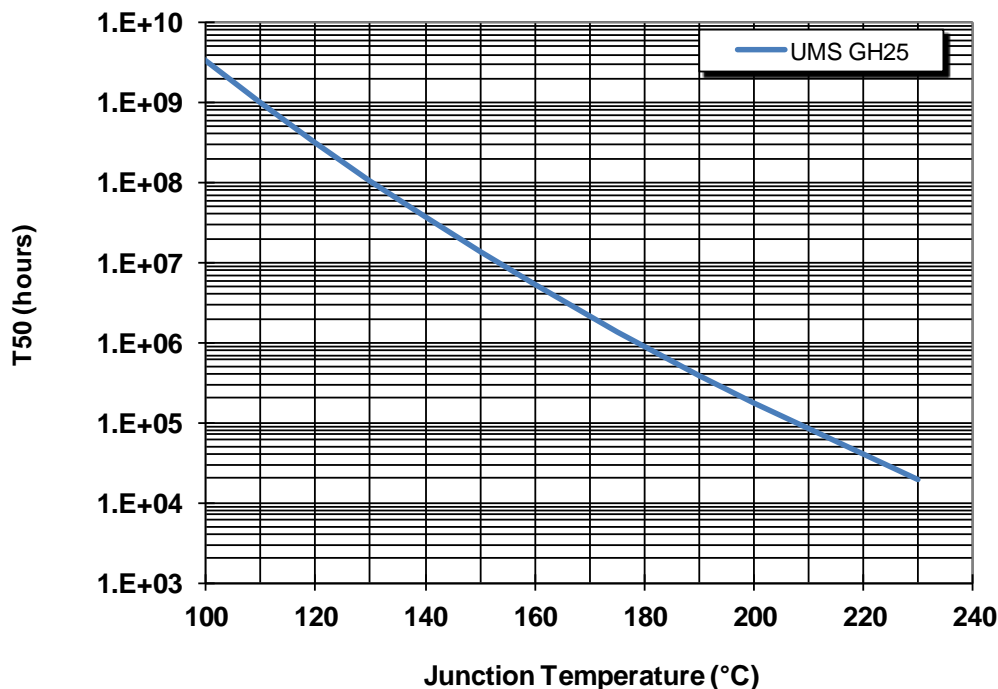

Typical S-parameters Measurements

Calibration and measurements are done on the connector reference accesses of the demonstration boards.

$T_{case} = +25^{\circ}C$, $V_{DS}=30V$, $I_{D,Q}=800mA$.

Pulsed input power : 400 μ s / 15%

S21, S11 & S22 versus Frequency

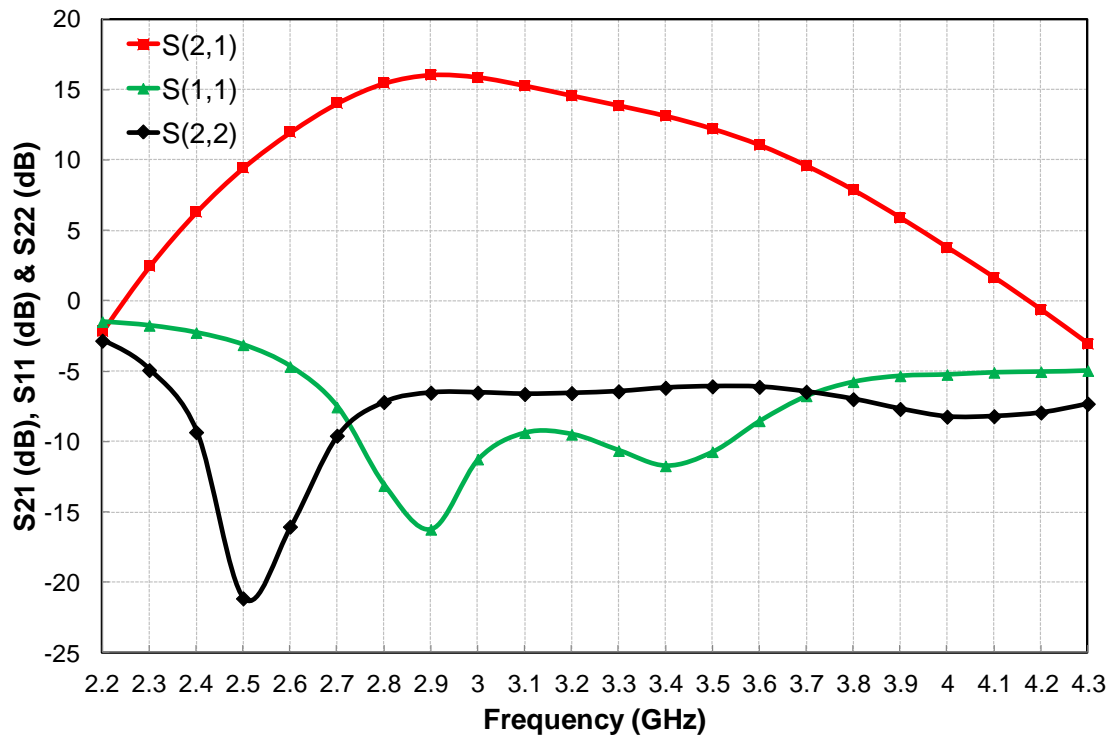

Typical Performance

Power Measurements results at package IN/OUT reference

$T_{case} = +25^{\circ}C$, $V_{DS} = +30V$, $I_{D,Q} = 800mA$ (Class AB)

Pulsed input power : 400 μ s / 15%

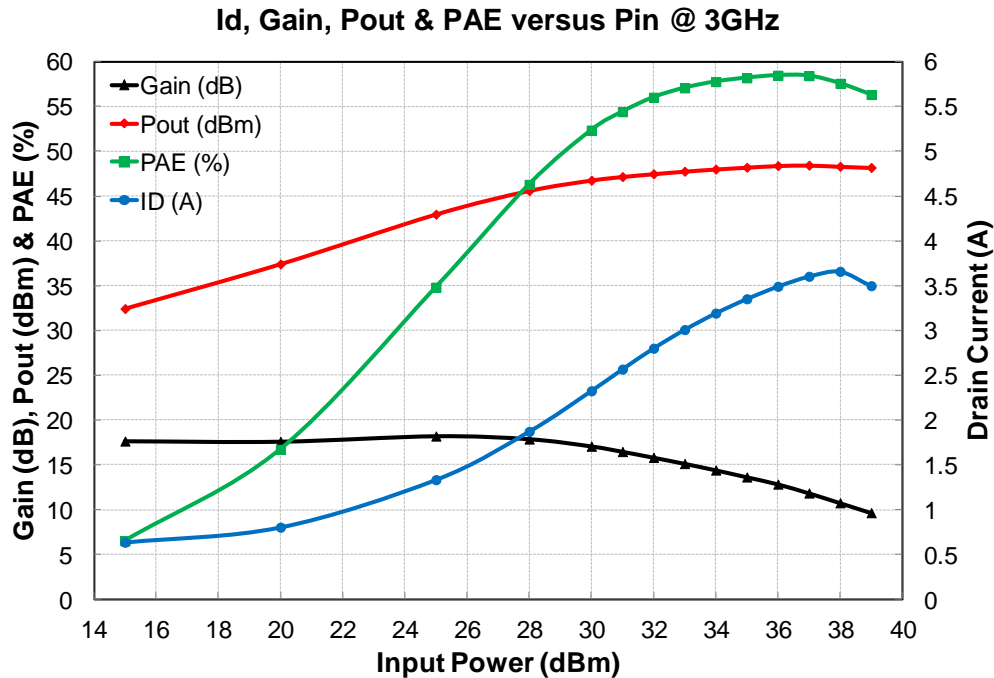

$T_{case} = +25^{\circ}C$, $V_{DS} = +30V$, $I_{D,Q} = 0mA$ (Class B)

Pulsed input power: 400 μ s / 15%

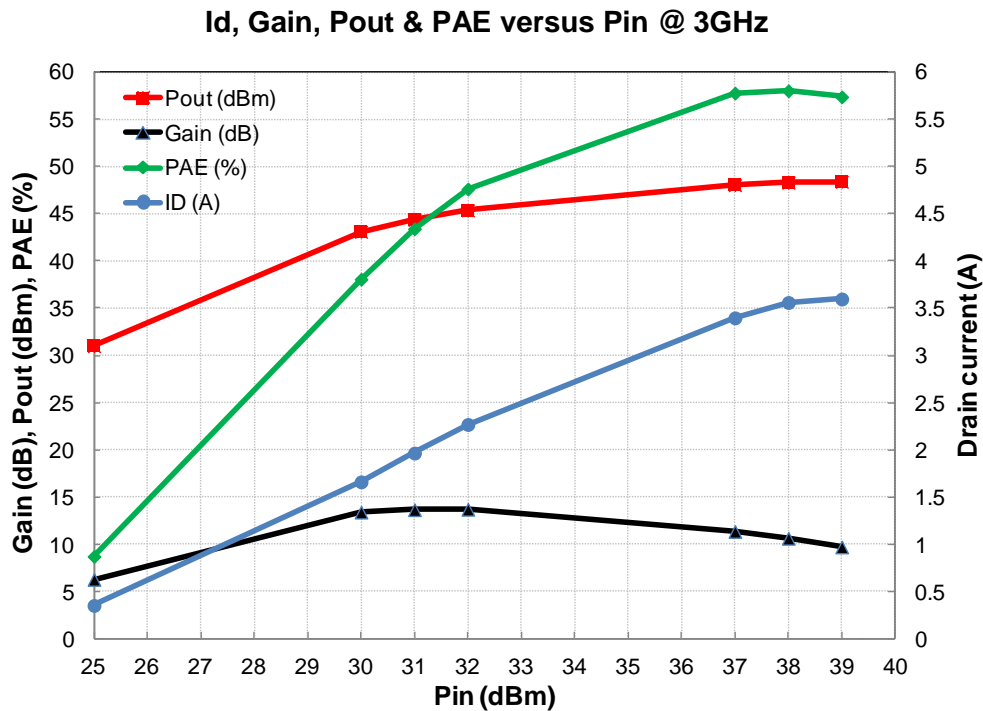

Typical Performance

Power Measurements results at package IN/OUT reference

$T_{case} = +25^{\circ}C$, $V_{DS} = +30V$, $I_{D,Q} = 800mA$ (Class AB)

Pulsed input power : 400 μ s / 15%

Linear Gain, Associated Gain, Pout & PAE versus Frequency @ Pin=37dBm

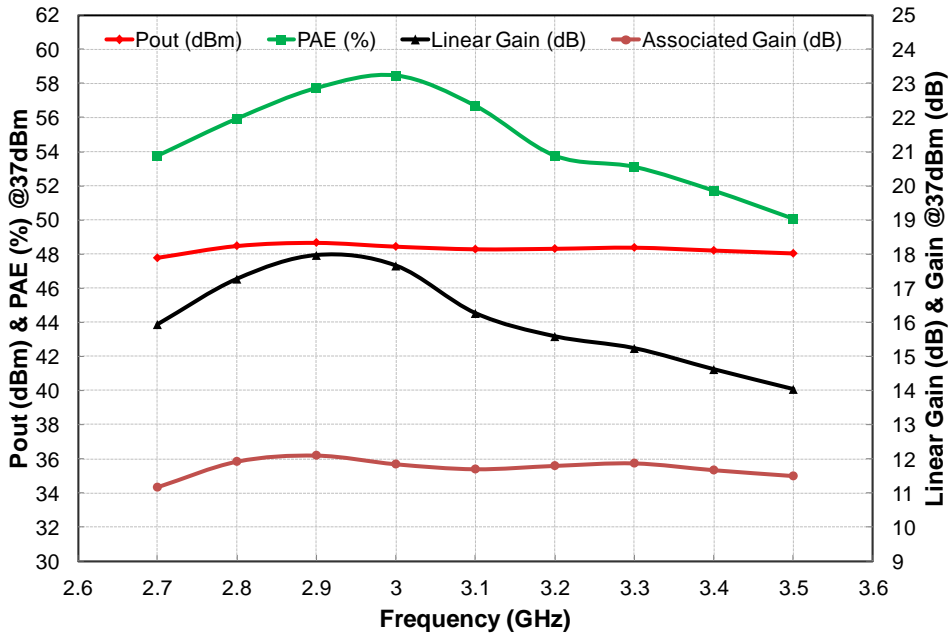

$T_{case} = +25^{\circ}C$, $V_{DS} = +30V$, $I_{D,Q} = 0mA$ (Class B)

Pulsed input power : 400 μ s / 15%

Power Gain, Pout & PAE versus Frequency @ Pin=38dBm

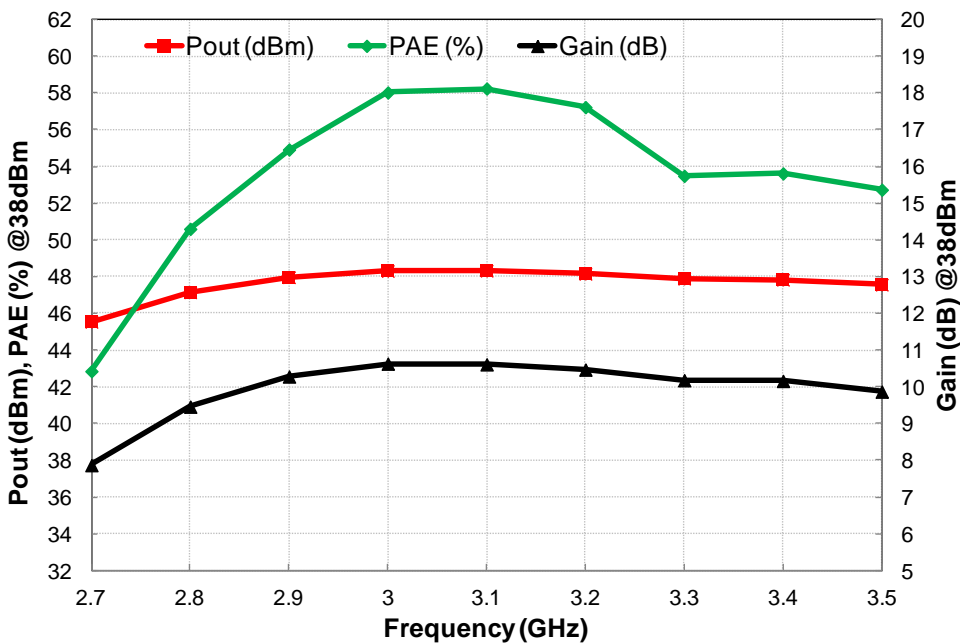

Typical Performance in Temperature

Power Measurements results at package IN/OUT reference

$T_{case} = -30^{\circ}C, +25^{\circ}C, +95^{\circ}C, V_{DS}=30V, V_{GS}=constant (I_{D_Q}=800mA @ 25^{\circ}C - Class AB)$

Pulsed input power : 400 μ s / 15%

Pout & PAE versus Frequency and Temperature @ Pin=37dBm

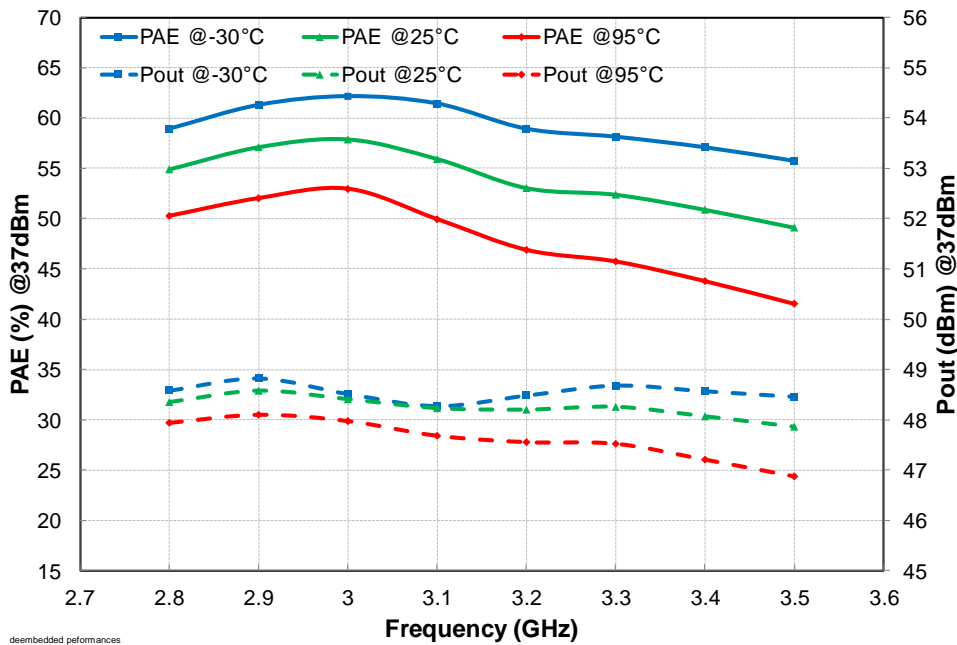

$T_{case} = 0^{\circ}C, +25^{\circ}C, +95^{\circ}C, V_{DS}=30V, V_{GS}=constant (I_{D_Q}=0mA @ 25^{\circ}C - Class B)$

Pulsed input power : 400 μ s / 15%

Pout & PAE versus Frequency and Temperature @ Pin=38dBm

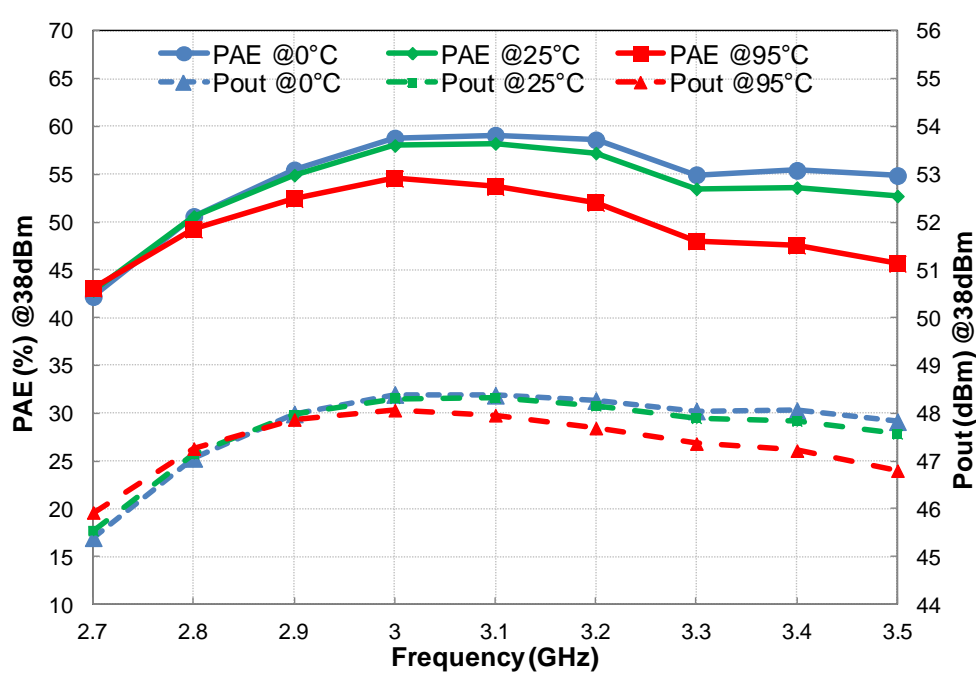

Typical Performance in Temperature

Power Measurements results at package IN/OUT reference

$T_{case} = -30^{\circ}C, +25^{\circ}C, +95^{\circ}C, V_{DS}=30V, V_{GS}=constant (I_{D_Q}=800mA @ 25^{\circ}C - Class AB)$

Pulsed input power : 400µs / 15%

Gain, Pout & PAE versus Pin and Temperature @ 3GHz

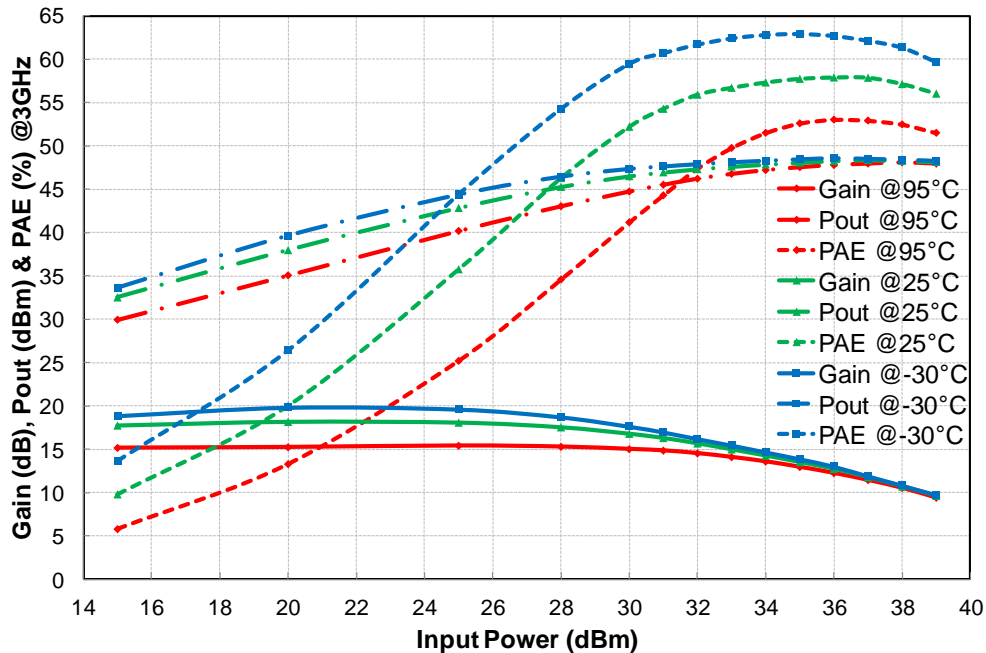

$T_{case} = 0^{\circ}C, +25^{\circ}C, +95^{\circ}C, V_{DS}=30V, V_{GS}=constant (I_{D_Q}=0mA @ 25^{\circ}C - Class B)$

Pulsed input power : 400µs / 15%

Gain, Pout & PAE versus Pin and Temperature @ 3GHz

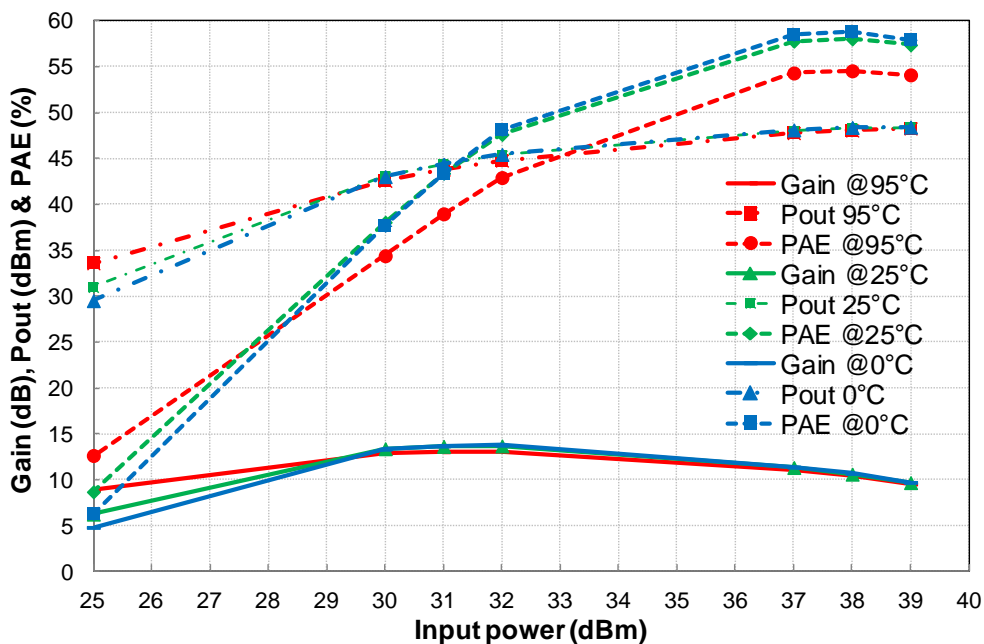

Package outline

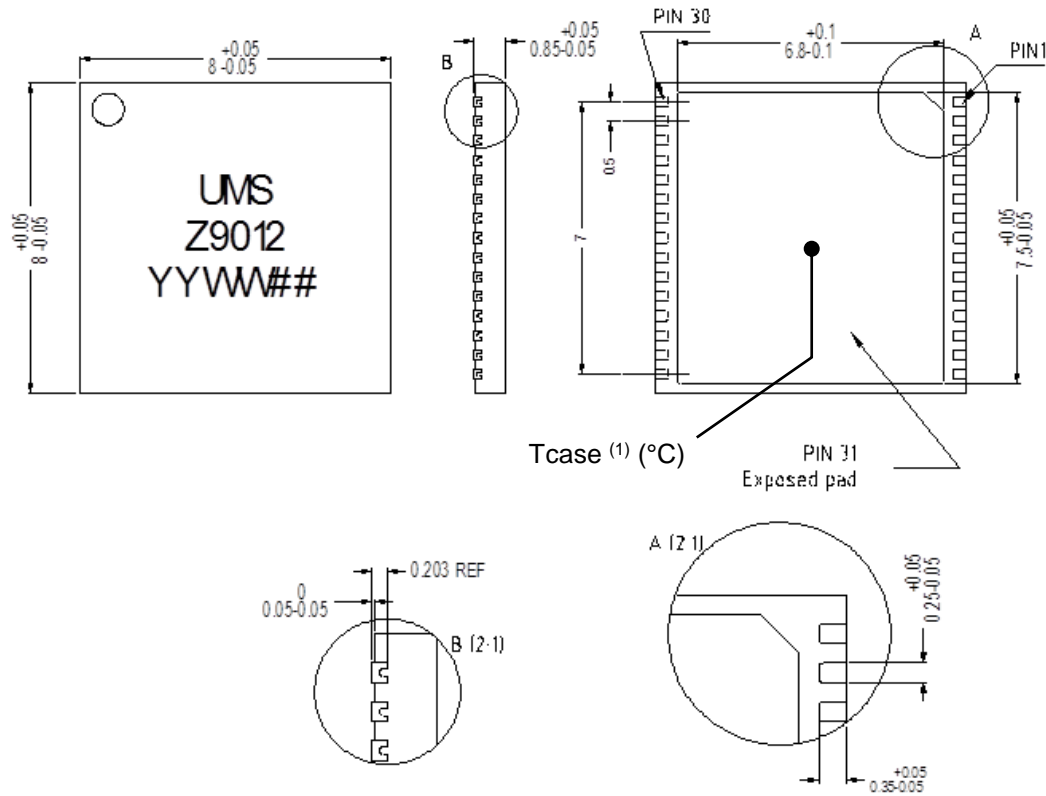

Finish : NiPdAu	1-NC	8-RF IN	15-NC	22-NC	29-NC
Units : mm	2-NC	9-NC	16-NC	23-RF OUT	30-NC
	3-NC	10-GND ⁽²⁾	17-NC	24-NC	31-GND ⁽²⁾
	4-NC	11-VG	18-NC	25-GND ⁽²⁾	
	5-VG	12-NC	19-VD	26-NC	
	6-GND ⁽²⁾	13-NC	20-NC	27-VD	
	7-NC	14-NC	21-GND ⁽²⁾	28-NC	

⁽¹⁾ Tcase locates the reference point used to monitor the device temperature. This point has been taken at the device / system interface to ease system thermal design.

⁽²⁾ It is strongly recommended to ground all pins marked "GND" through the PCB board. Ensure that the PCB board is designed to provide the best possible ground to the package.

Evaluation board (Ref. 61503234)

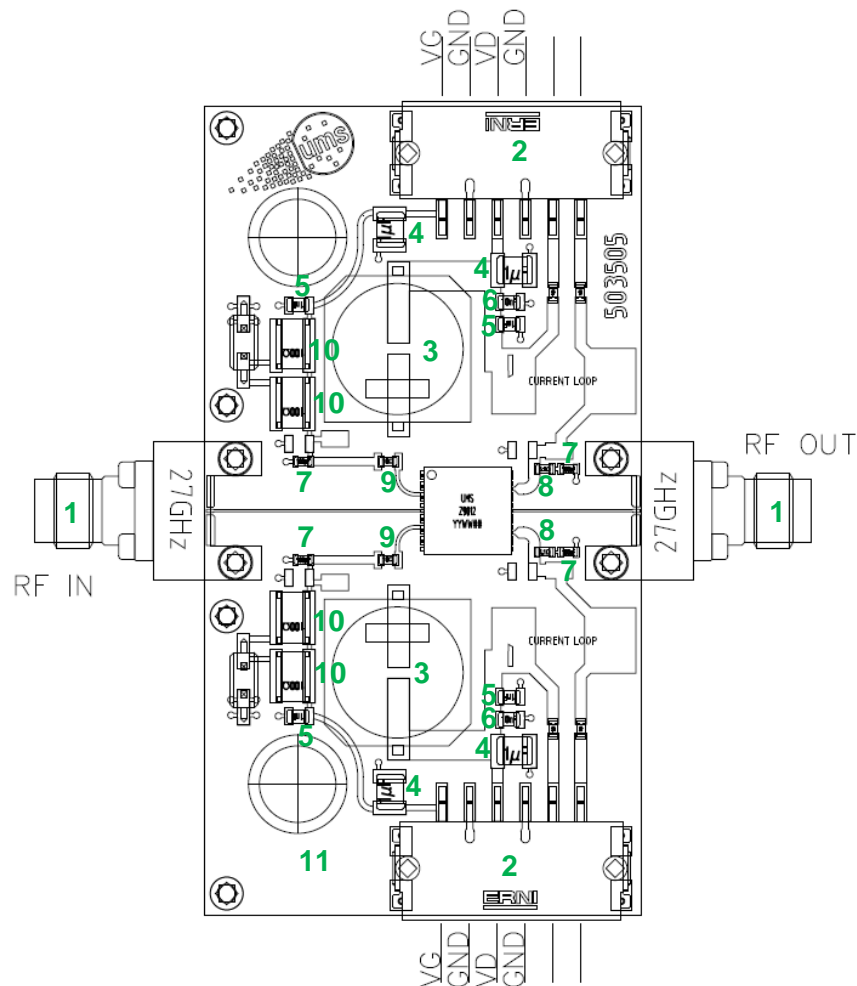

Bill of Materials (Ref. 61503234)

Designation	Component	Value - Description	Qty
1	RF Connector	RF-SMA DC-27GHz	2
2	DC Connector	CMS 6cts	2
3	Capacitor	68 μ F +/-20%. 100V	2
4	Capacitor	1 μ F +/-10%. 1210 100V	2
5	Capacitor	1nF +/-5%. 0805 100V	4
6	Capacitor	10nF +/-10%. 0805 100V	2
7	Capacitor	100pF +/-5%. 0603 250V	4
8	Resistor	5.1 Ω +/-1%. 0603 100mW	2
9	Resistor	10 Ω +/-1%. 0603 0.1W	4
10	Resistor	100 Ω +/-1%. RCL 1218 1W	4
11	PCB	TACONIC RF35P-0080-CH/Cu1/ Thickness=0.008in (0.203mm)/ Bottom Copper layer: 1mm	1

DC Schematic (Ref. 61503234)

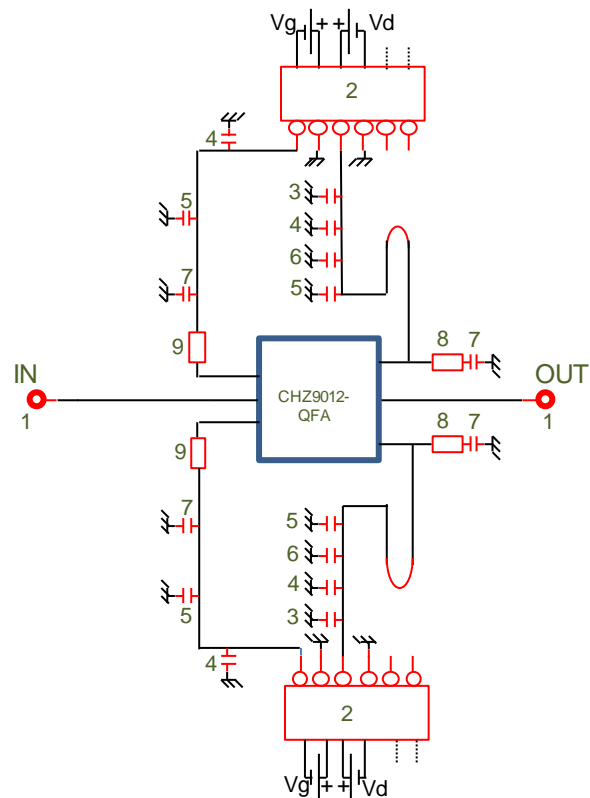

The CHZ9012-QFA does not include any high value decoupling capacitor in the package. Therefore, it is mandatory to provide a good external DC decoupling on the PCB board, as close as possible to the package (See paragraph "Evaluation board").

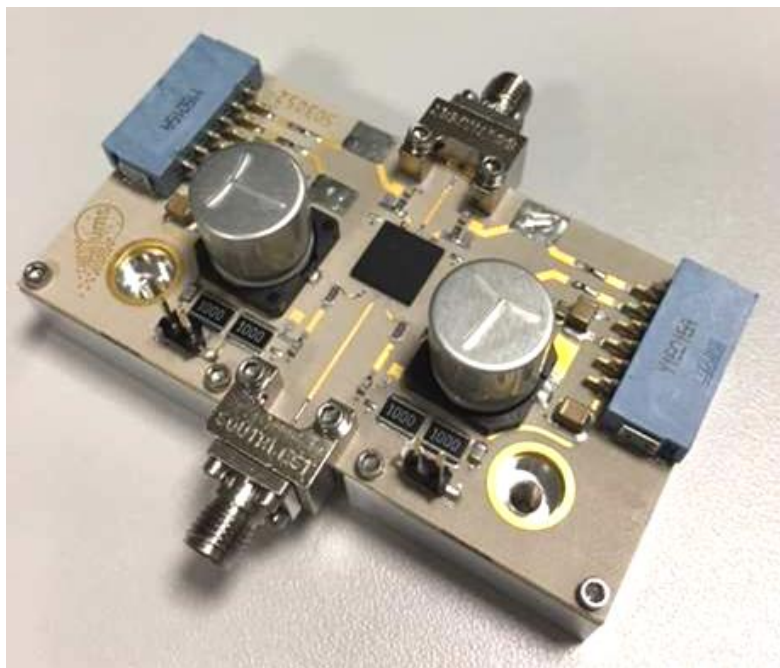
Demonstration Amplifier Circuit (Ref. 61503234)**ESD sensitivity**

Standard	Value
JEDEC JESD22-A114	HBM Class 1A ($\leq 500V$)
JEDEC JESD22-A115	MM Class A ($\leq 100V$)

Package Information

Parameter	Value
Package body material	RoHS-compliant
	Low stress Injection Molded Plastic
Lead finish	NiPdAu
MSL Rating	MSL3 (IPC/JEDEC J-STD-020)

Qualification domain

This part is qualified according to UMS standards including uHAST stress (Accelerated Moisture Resistance-Unbiased HAST) based on JEDEC JESD22-A118.

Recommended package footprint

Refer to the application note AN0017 available at <https://www.ums-rf.com> for package footprint recommendations.

SMD mounting procedure

For the mounting process, standard techniques involving solder paste and a suitable reflow process can be used. For further details, see application note AN0017.

Recommended environmental management

UMS products are compliant with the regulation in particular with the directives RoHS N°2011/65 and REACH N°1907/2006. More environmental data are available in the application note AN0019 also available at <https://www.ums-rf.com>.

Recommended ESD management

Refer to the application note AN0020 available at <https://www.ums-rf.com> for ESD sensitivity and handling recommendations for the UMS package products.

Ordering Information

DFN 8x8 package:

CHZ9012-QFA/XY

Stick: XY = 20

Information furnished is believed to be accurate and reliable. However **United Monolithic Semiconductors S.A.S.** assumes no responsibility for the consequences of use of such information nor for any infringement of patents or other rights of third parties which may result from its use. No license is granted by implication or otherwise under any patent or patent rights of **United Monolithic Semiconductors S.A.S.** Specifications mentioned in this publication are subject to change without notice. This publication supersedes and replaces all information previously supplied. **United Monolithic Semiconductors S.A.S.** products are not authorised for use as critical components in life support devices or systems without express written approval from **United Monolithic Semiconductors S.A.S.**