

DC-14GHz Attenuator

GaAs Monolithic Microwave IC in SMD leadless package

Description

The CHT3091-FAB is a variable DC-14GHz attenuator designed for a wide range of applications, from space, military to commercial communication systems.

It is proposed in leadless surface mount hermetic metal ceramic 6x6mm² package. The circuit is manufactured with a MESFET process, 0.7μm gate length, via holes through the substrate, air bridges and electron beam gate lithography.

It is supplied in RoHS compliant SMD package.

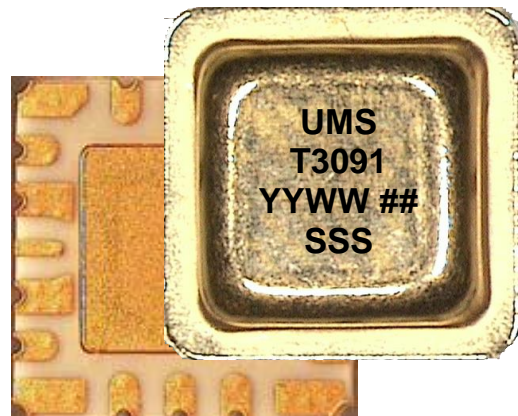

Main Features

- Broadband performances: DC-14GHz
- 15dBm typical input @1dB compression point (any attenuation, 1-14GHz)
- DC bias: $-5V < V_S < 0V$; $-5V < V_P < 0V$
- 6x6mm² hermetic metal ceramic package

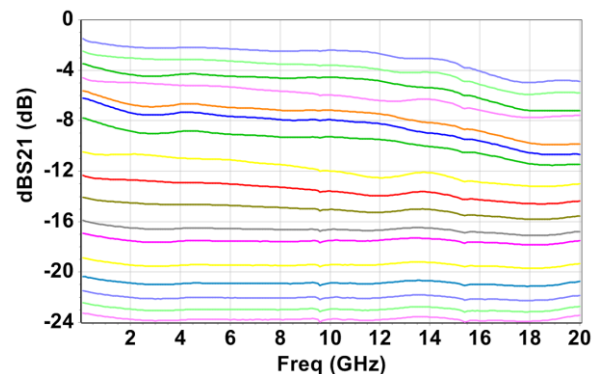

Main Electrical Characteristics

Tamb.= +25°C

Symbol	Parameter	Min	Typ	Max	Unit
F _{in}	Input frequency range	DC		14	GHz
Min Att.	Minimum attenuation S21 (V _S =0V; V _P =-5V)		2.5		dB
Max Att.	Maximum attenuation S21 (V _S =-5V; V _P =0V)	20	23		dB
P _{in} 1dB	Input 1dB comp. point (any Att., F _{in} > 1GHz)		15		dBm

ESD Protection: Electrostatic discharge sensitive device. Observe handling precautions!

Electrical Characteristics

Tamb.= +25°C

Symbol	Parameter	Min	Typ	Max	Unit
F _{in}	Input frequency range	DC		14	GHz
Min Att.	Minimum attenuation S21 (V _S =0V;V _P =-5V)		2.5	4.0	dB
Max Att.	Maximum attenuation S21 (V _S =-5V;V _P =0V)	20	23		dB
VSWR _{in}	Input VSWR (any attenuation)		2:1		
VSWR _{out}	Output VSWR (any attenuation)		2:1		
P _{in} 1dB	Input 1dB compression point (any attenuation, 1 – 14GHz)		15		dBm

These values are representative of on board measurements as defined on the drawing 503566 (see below).

Absolute Maximum Ratings ⁽¹⁾T_{amb.} = +25°C

Symbol	Parameter	Values	Unit
V _S	V _S control voltage	-6V to +0.6V	V
V _P	V _P control voltage	-6V to +0.6V	V
T _j	Junction temperature	175	°C
P _{in}	RF input power	20	dBm

⁽¹⁾ Operation of this device above anyone of these parameters may cause permanent damage.

Temperature Range

T _a	Operating temperature range	-40 to +85	°C
T _{stg}	Storage temperature range	-50 to +150	°C

Typical Bias ConditionsT_{amb.} = +25°C

Symbol	Pad N°	Parameter	Values	Unit
V _S	2	V _S control voltage	0 to -5	V
V _P	4	V _P control voltage	-5 to 0	V

Device thermal performances

All the figures given in this section are obtained assuming that the packaged device is only cooled down by conduction through the package thermal pad (no convection mode considered).

The temperature is monitored at the package back-side interface (T_{case}).

The system maximum temperature must be adjusted in order to guarantee that $T_{junction}$ remains below the maximum value specified in the Absolute Maximum Ratings table.

So, the system PCB must be designed to comply with this requirement.

Parameter	Biassing conditions	$T_{junction}$ (°C)	R_{TH} (°C/W)	T_{50} (hours)
$R_{TH}^{(1)}$ Thermal Resistance (Junction to Case)	$V_s=0V$, $V_p=-5V^{(2)}$ $P_{in} = 20dBm$ $P_{diss} = 0.1W$	114	292	$7.0E+8$

⁽¹⁾ Assuming 85°C T_{case}

⁽²⁾ Worst case for T_j

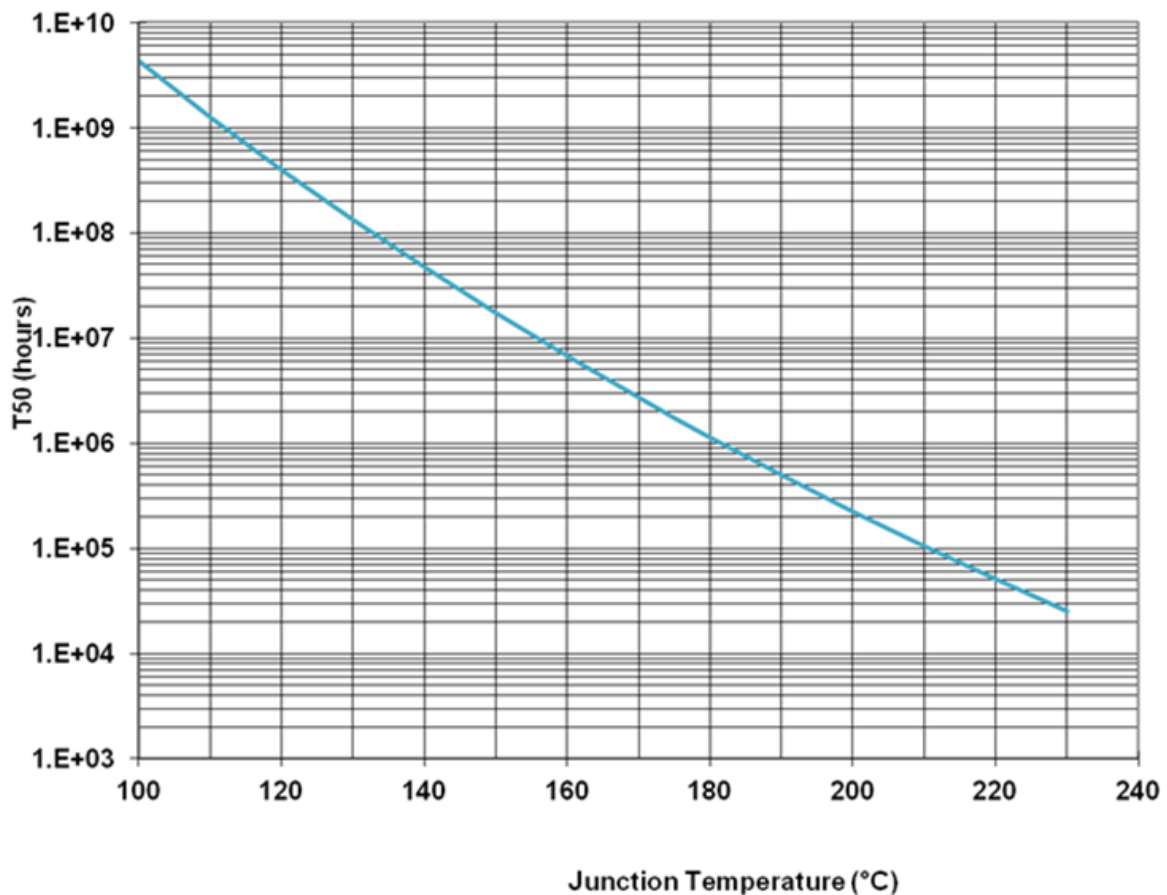

Typical Package Sij parameters

Tamb.= +25°C, V_S = 0V, V_P = -5V

Freq (GHz)	S11 (dB)	PhS11 (°)	S21 (dB)	PhS21 (°)	S12 (dB)	PhS12 (°)	S22 (dB)	PhS22 (°)
1.00	-16.16	-28.84	-2.03	-29.87	-2.10	-30.02	-15.75	-21.39
1.50	-16.45	-42.30	-2.07	-44.25	-2.14	-44.39	-15.66	-31.36
2.00	-16.82	-55.39	-2.09	-58.66	-2.16	-58.82	-15.48	-41.56
2.50	-17.30	-69.15	-2.11	-73.11	-2.18	-73.31	-15.28	-52.66
3.00	-17.93	-82.44	-2.13	-87.60	-2.19	-87.77	-15.05	-63.67
3.50	-18.65	-95.85	-2.14	-102.10	-2.21	-102.27	-14.76	-75.46
4.00	-19.67	-109.78	-2.15	-116.64	-2.22	-116.80	-14.52	-87.87
4.50	-20.85	-123.08	-2.16	-131.18	-2.23	-131.35	-14.23	-100.39
5.00	-22.48	-136.77	-2.18	-145.77	-2.24	-145.91	-13.98	-113.70
5.50	-24.72	-149.06	-2.19	-160.34	-2.25	-160.56	-13.75	-127.01
6.00	-28.31	-160.94	-2.20	-174.97	-2.26	-175.22	-13.57	-140.81
6.50	-32.91	-179.30	-2.24	170.31	-2.31	170.10	-13.21	-154.87
7.00	-46.97	-158.86	-2.26	155.63	-2.33	155.42	-13.05	-168.64
7.50	-35.51	-42.60	-2.29	140.90	-2.36	140.69	-12.91	176.97
8.00	-28.26	-51.14	-2.33	126.16	-2.40	125.96	-12.83	162.56
8.50	-24.46	-63.20	-2.37	111.39	-2.43	111.18	-12.73	147.52
9.00	-21.64	-74.27	-2.41	96.57	-2.48	96.36	-12.73	131.66
9.50	-19.43	-86.96	-2.46	81.74	-2.53	81.52	-12.82	115.42
10.00	-17.64	-99.45	-2.54	67.20	-2.61	67.01	-12.98	99.59
10.50	-16.10	-111.79	-2.59	52.31	-2.65	52.10	-13.10	81.76
11.00	-14.79	-123.85	-2.66	37.47	-2.73	37.28	-13.33	63.43
11.50	-13.58	-135.08	-2.73	22.62	-2.80	22.42	-13.66	43.78
12.00	-12.48	-146.79	-2.81	7.81	-2.88	7.61	-14.05	23.16
12.50	-11.60	-158.57	-2.90	-7.00	-2.97	-7.23	-14.32	1.45
13.00	-10.76	-170.08	-3.01	-21.79	-3.07	-21.99	-14.29	-20.87
13.50	-10.04	178.10	-3.13	-36.54	-3.20	-36.75	-14.07	-44.69
14.00	-9.53	166.02	-3.25	-51.16	-3.32	-51.39	-13.92	-66.70
14.50	-9.15	154.14	-3.39	-65.61	-3.47	-65.82	-13.34	-88.44
15.00	-8.69	141.69	-3.46	-80.18	-3.53	-80.40	-13.05	-108.80
15.50	-8.51	129.28	-3.56	-94.70	-3.63	-94.93	-12.49	-126.20
16.00	-8.43	115.80	-3.66	-109.08	-3.74	-109.29	-11.98	-142.75
16.50	-8.61	102.30	-3.71	-123.44	-3.78	-123.68	-11.64	-157.94
17.00	-8.90	88.06	-3.73	-137.91	-3.80	-138.14	-11.35	-169.67
17.50	-9.36	73.27	-3.75	-152.79	-3.82	-153.02	-10.94	-177.70
18.00	-10.13	56.46	-3.76	-167.74	-3.84	-168.01	-10.85	167.92
18.50	-11.18	37.39	-3.79	177.03	-3.86	176.82	-10.59	158.76
19.00	-12.53	13.70	-3.81	161.52	-3.88	161.29	-10.50	150.90
19.50	-14.28	-14.64	-3.83	145.82	-3.90	145.53	-10.01	145.32
20.00	-15.23	-51.79	-3.92	129.60	-4.00	129.32	-9.44	138.51
20.50	-14.70	-95.25	-4.07	113.11	-4.15	112.91	-8.91	132.81
21.00	-12.74	-130.86	-4.33	96.84	-4.40	96.60	-8.18	126.28

Typical Package Sij parameters

Tamb.= +25°C, V_S = -5V, V_P = 0V

Freq (GHz)	S11 (dB)	PhS11 (°)	S21 (dB)	PhS21 (°)	S12 (dB)	PhS12 (°)	S22 (dB)	PhS22 (°)
1.00	-17.28	-17.86	-23.36	-26.05	-23.43	-26.21	-17.27	-15.63
1.50	-17.26	-28.85	-23.40	-38.55	-23.47	-38.68	-17.20	-25.44
2.00	-17.30	-39.43	-23.43	-51.03	-23.49	-51.22	-17.16	-34.96
2.50	-17.41	-50.21	-23.44	-63.54	-23.51	-63.82	-17.17	-44.84
3.00	-17.57	-60.32	-23.45	-76.17	-23.52	-76.35	-17.20	-54.01
3.50	-17.72	-70.48	-23.46	-88.75	-23.53	-88.92	-17.19	-63.53
4.00	-17.99	-80.27	-23.47	-101.37	-23.54	-101.52	-17.29	-72.90
4.50	-18.19	-89.79	-23.47	-113.95	-23.54	-114.11	-17.31	-82.17
5.00	-18.49	-99.09	-23.48	-126.55	-23.54	-126.66	-17.38	-91.61
5.50	-18.81	-107.02	-23.48	-139.10	-23.54	-139.31	-17.49	-100.10
6.00	-19.17	-113.51	-23.48	-151.75	-23.54	-151.96	-17.64	-107.57
6.50	-19.46	-128.20	-23.48	-164.39	-23.55	-164.62	-17.12	-120.18
7.00	-19.69	-135.86	-23.47	-177.06	-23.54	-177.28	-17.12	-128.84
7.50	-19.94	-143.47	-23.46	170.24	-23.52	170.02	-17.13	-137.87
8.00	-20.13	-149.43	-23.44	157.58	-23.51	157.38	-17.09	-146.00
8.50	-20.24	-155.50	-23.44	144.87	-23.51	144.67	-17.07	-154.59
9.00	-20.43	-160.49	-23.42	132.22	-23.48	132.02	-17.14	-163.07
9.50	-20.38	-164.96	-23.39	119.47	-23.46	119.25	-17.22	-170.69
10.00	-20.19	-167.63	-23.43	107.00	-23.50	106.79	-17.15	-176.87
10.50	-19.89	-172.40	-23.37	94.26	-23.44	94.05	-17.16	174.95
11.00	-19.48	-176.65	-23.34	81.71	-23.41	81.47	-17.15	167.73
11.50	-19.28	179.96	-23.30	68.83	-23.37	68.64	-17.31	161.56
12.00	-18.73	175.87	-23.26	56.35	-23.32	56.16	-17.20	156.58
12.50	-18.31	170.78	-23.21	43.88	-23.28	43.69	-17.18	150.94
13.00	-18.00	166.85	-23.15	31.05	-23.21	30.84	-17.34	144.65
13.50	-17.60	162.09	-23.08	18.64	-23.14	18.45	-17.50	140.91
14.00	-17.39	157.06	-22.98	5.69	-23.05	5.48	-17.48	135.59
14.50	-17.28	153.24	-22.97	-7.36	-23.05	-7.58	-17.58	133.80
15.00	-16.81	148.28	-22.85	-19.76	-22.92	-19.98	-17.20	128.28
15.50	-16.70	144.45	-22.78	-32.46	-22.86	-32.69	-17.38	124.43
16.00	-16.59	139.58	-22.61	-45.31	-22.69	-45.53	-17.35	122.60
16.50	-16.76	136.53	-22.48	-58.97	-22.55	-59.20	-17.05	119.21
17.00	-16.66	134.90	-22.39	-72.84	-22.46	-73.10	-17.19	116.61
17.50	-16.44	133.05	-22.52	-86.49	-22.59	-86.72	-16.66	115.19
18.00	-16.27	131.63	-22.48	-99.14	-22.56	-99.44	-16.52	111.60
18.50	-16.12	130.70	-22.51	-112.24	-22.58	-112.47	-16.06	108.64
19.00	-15.87	130.02	-22.31	-125.73	-22.39	-125.94	-15.79	103.59
19.50	-14.93	129.86	-22.40	-139.04	-22.47	-139.29	-15.38	102.67
20.00	-14.41	126.82	-22.36	-153.16	-22.43	-153.43	-14.74	98.44
20.50	-13.54	124.97	-22.43	-166.42	-22.51	-166.62	-14.49	93.19
21.00	-12.80	121.53	-22.46	-179.90	-22.53	179.82	-14.21	88.37

Typical Board Measurements

Min attenuation $V_S = 0V$; $V_P = -5V$ Temperature : -55, -40, +25, +85, +125°C

Gain versus Frequency and Temperature

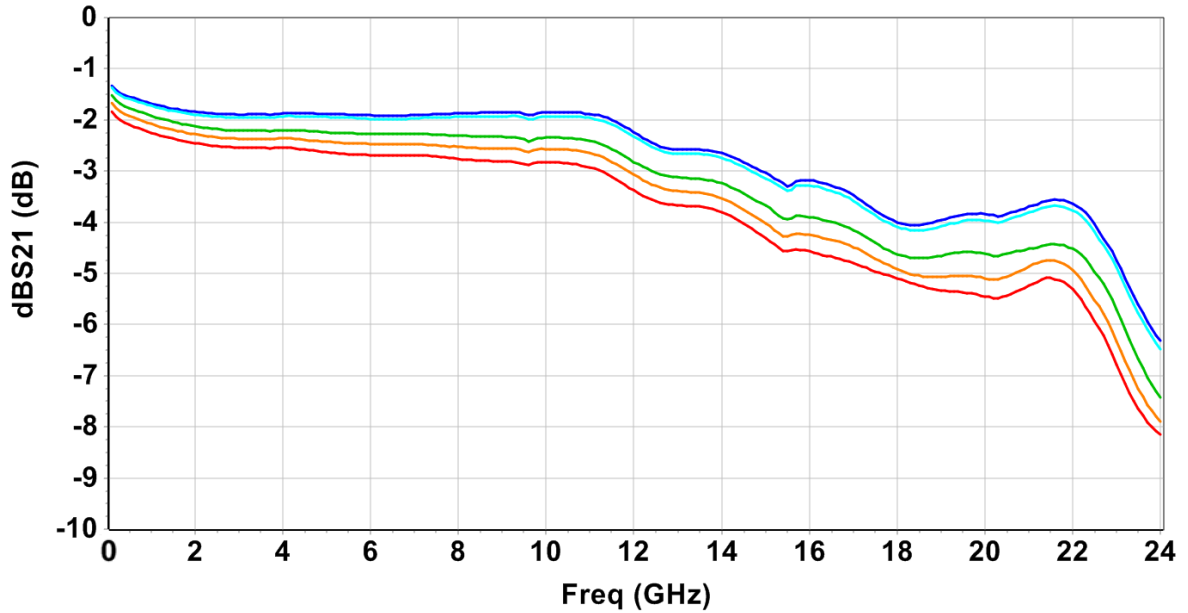

Input Return Loss versus Frequency and Temperature

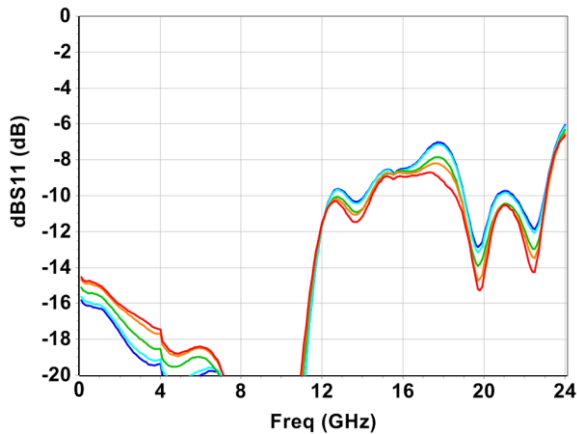

Output Return Loss versus Frequency and Temperature

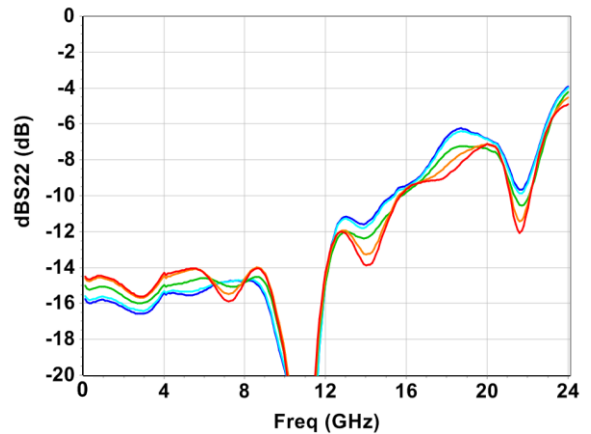

Typical Board Measurements

Max attenuation $V_S = -5V$; $V_P = 0V$ Temperature : -55, -40, +25, +85, +125°C

Gain versus Frequency and Temperature

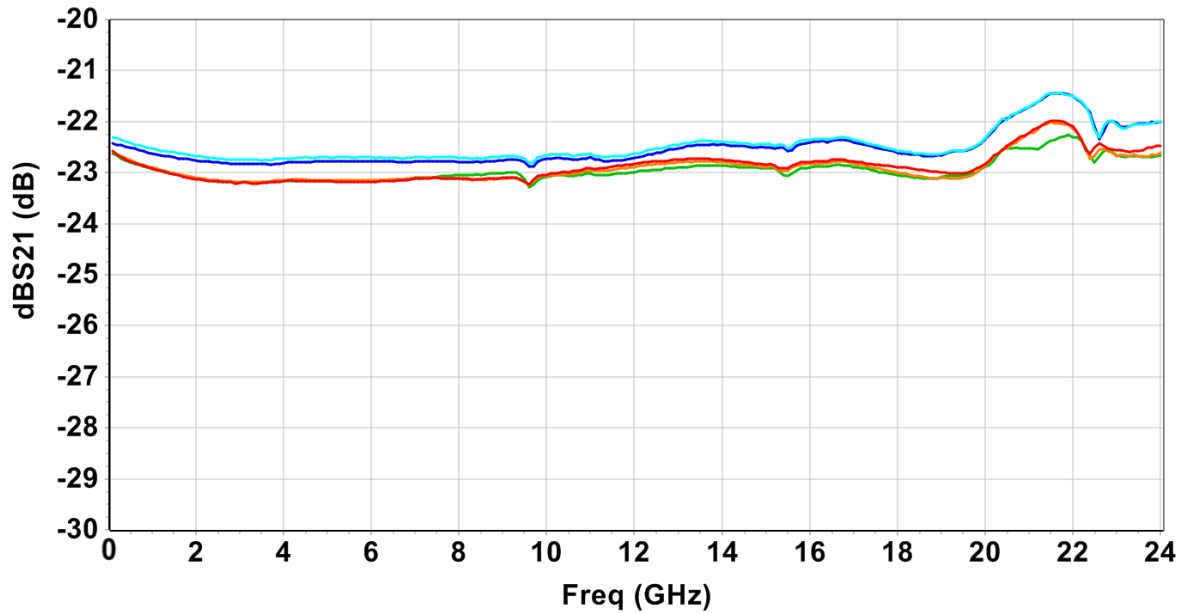

Input Return Loss versus Frequency and Temperature

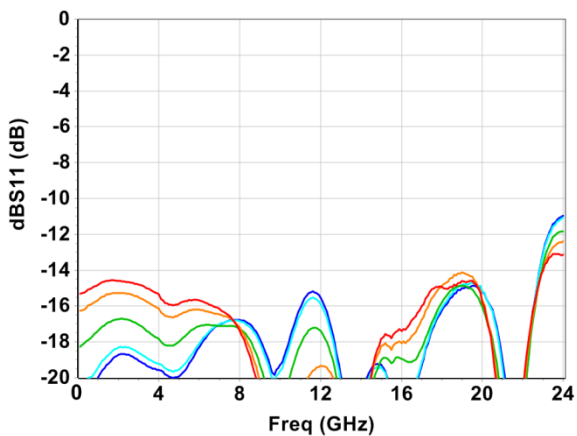

Output Return Loss versus Frequency and Temperature

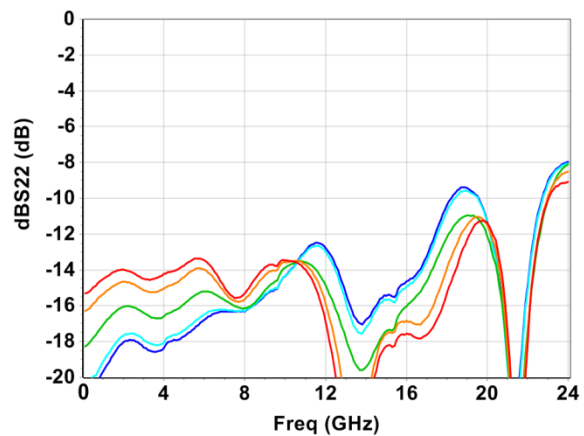

Typical Board Measurements

Tamb.= +25°C

Gain versus Frequency and Gain Control Voltage

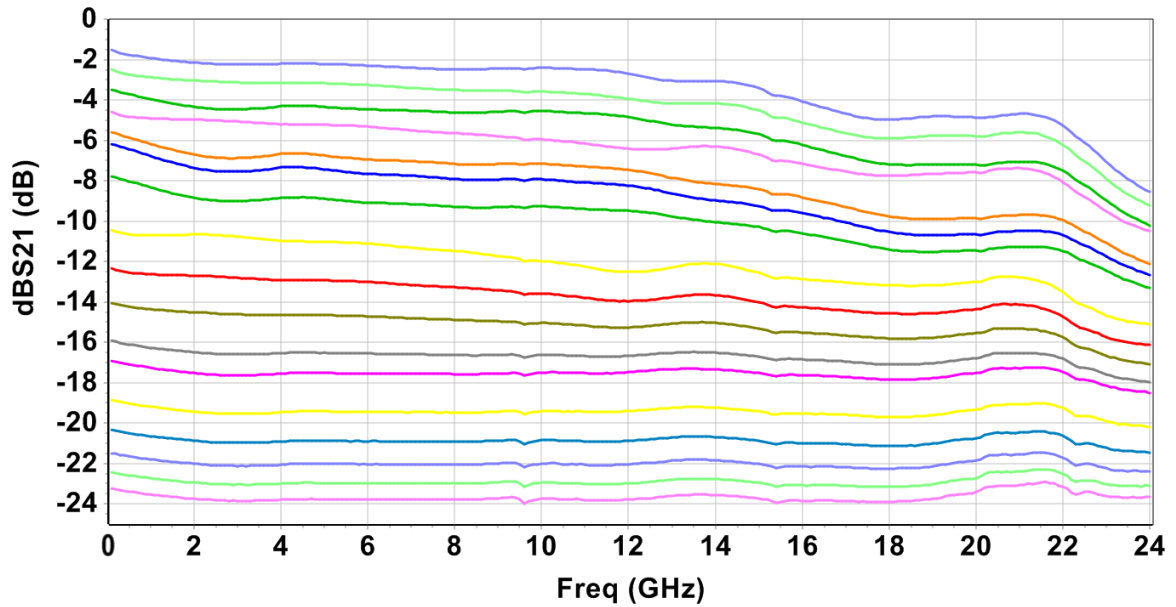

Input Return Loss versus Frequency and Gain Control Voltage

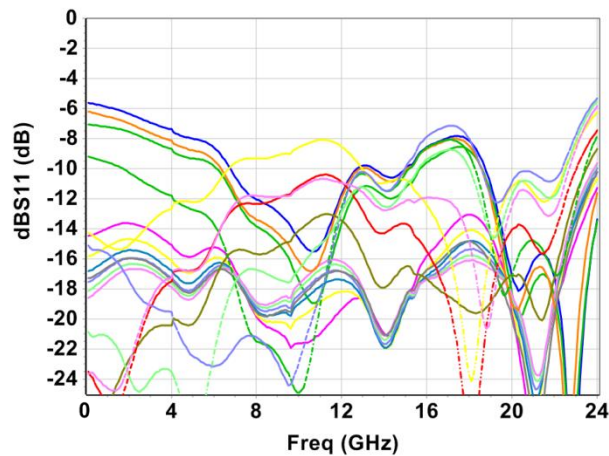

Output Return Loss versus Frequency and Gain Control Voltage

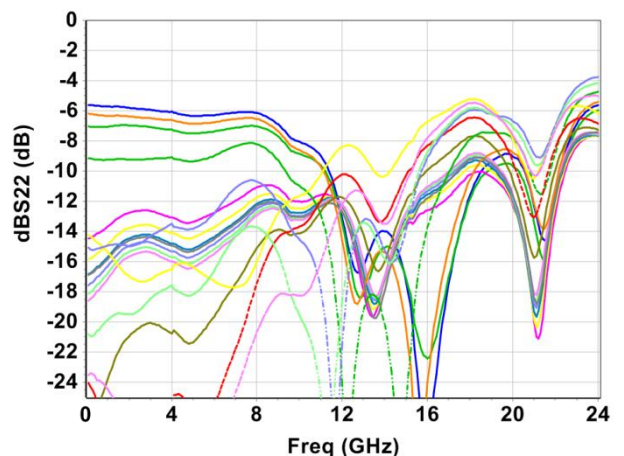

Typical Board Measurements

Gain versus Gain Control Voltage and Frequency @ 25°C

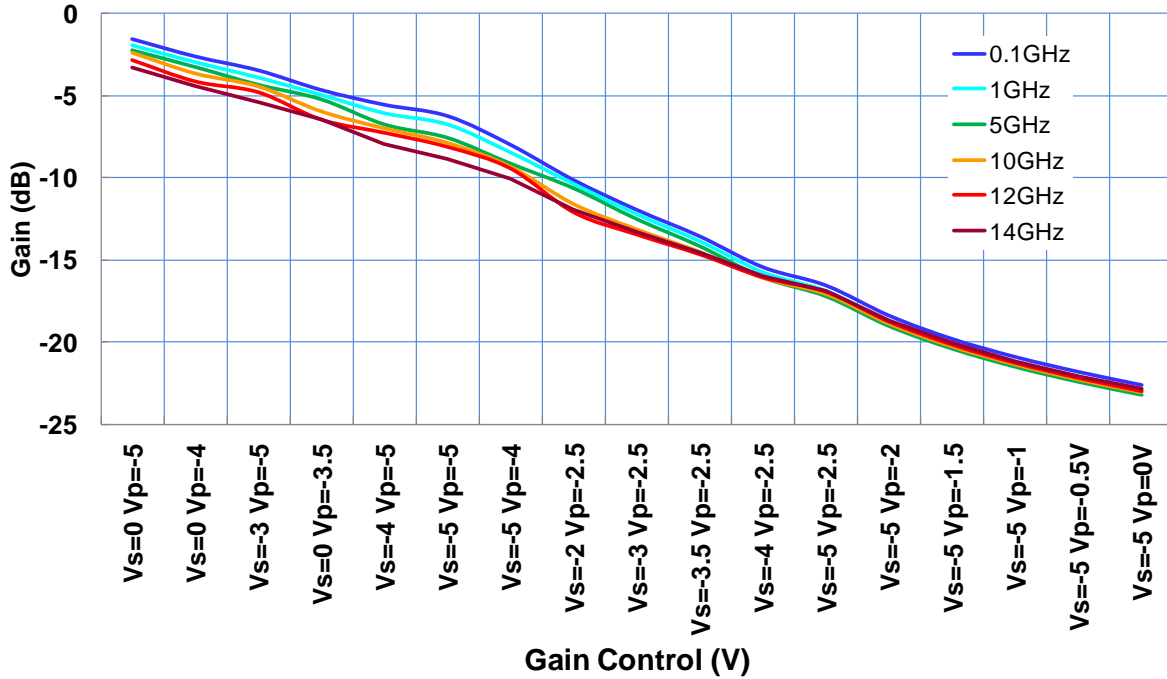

Gain versus Input Power and Gain Control Voltage
Frequency = 1GHz ; Temperature : -40, +25, +85°C

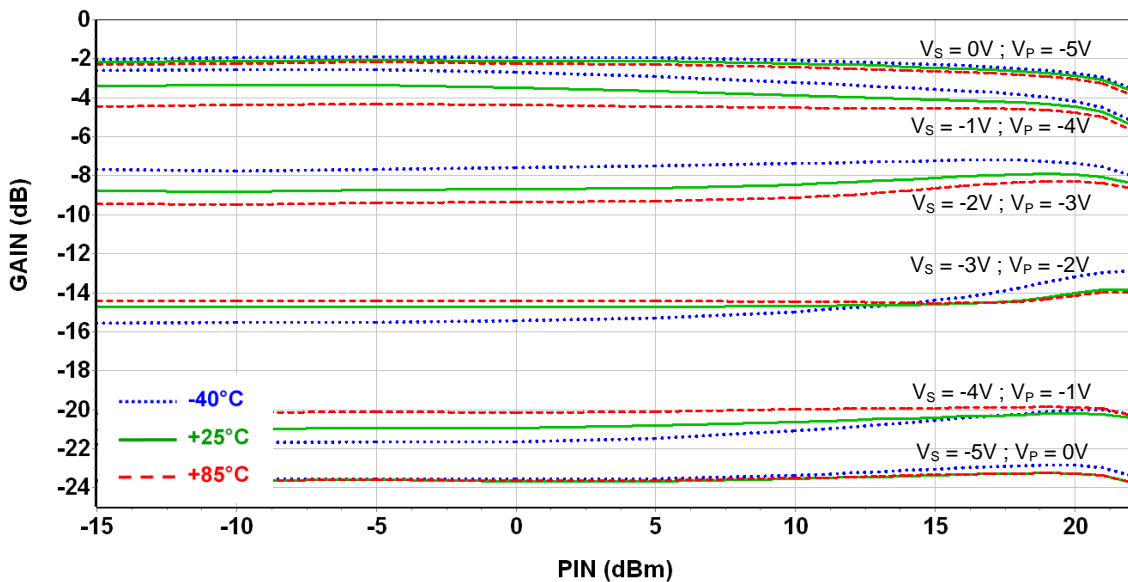

Typical Board Measurements

Gain versus Input Power and Gain Control Voltage

Frequency = 7GHz ; Temperature : -40, +25, +85°C

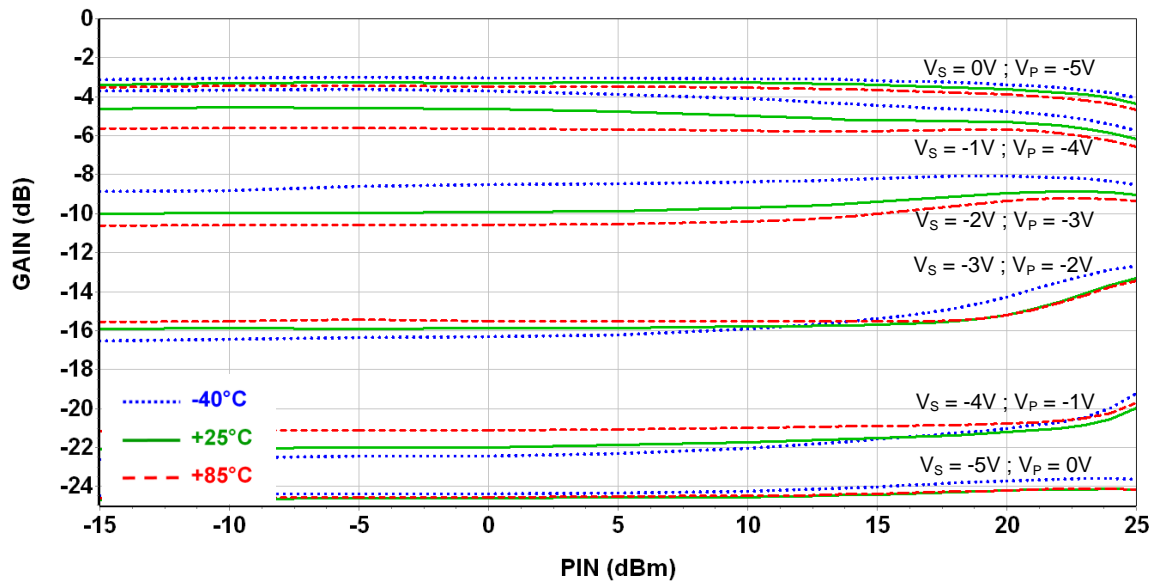

Gain versus Input Power and Gain Control Voltage

Frequency = 13GHz ; Temperature : -40, +25, +85°C

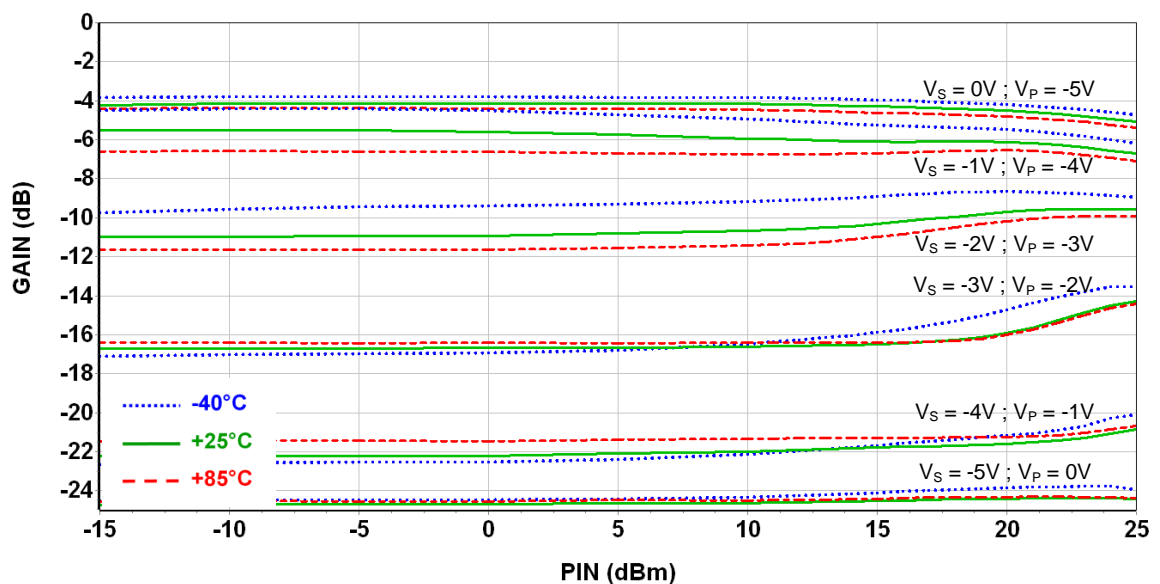

Package outline (1)

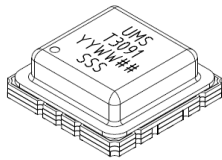
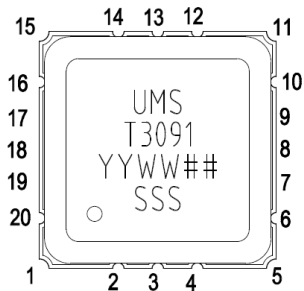
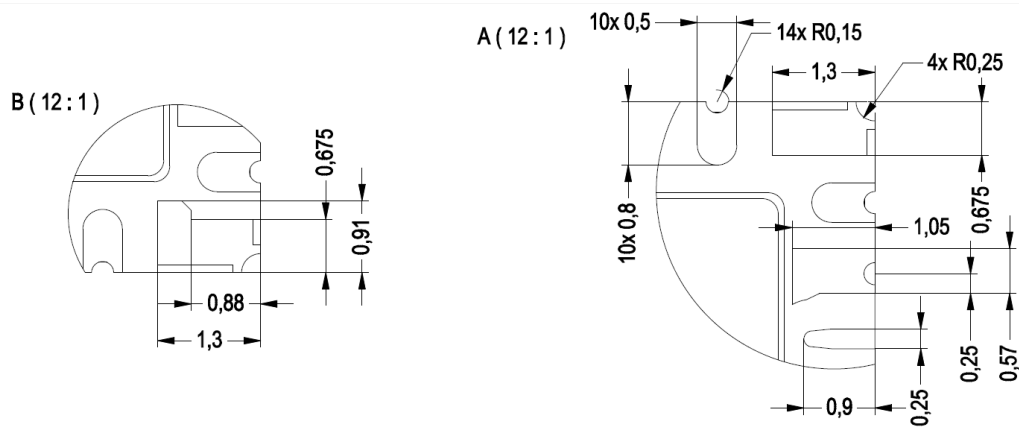
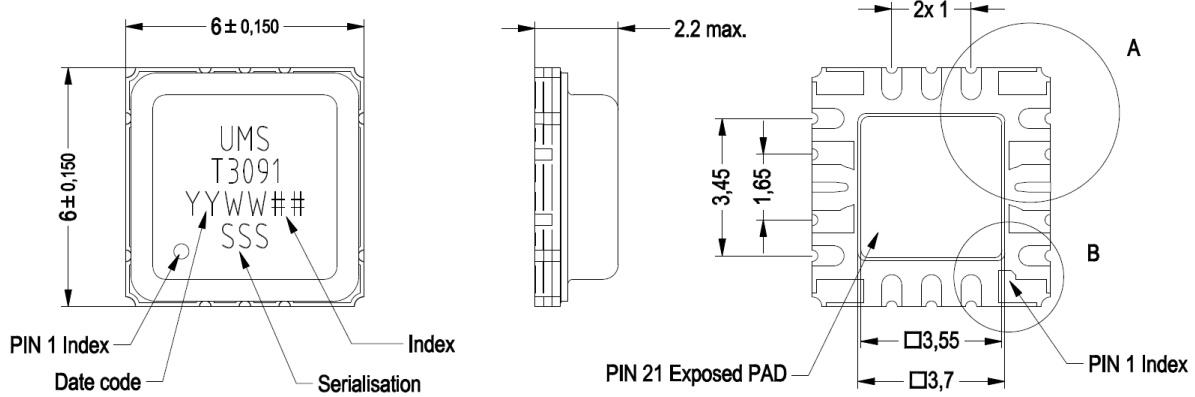

1- GND	8- RF OUT	15- GND
2- VS	9- GND	16- Nc
3- Nc	10- Nc	17- GND
4- VP	11- GND	18- RF IN
5- GND	12- Nc	19- GND
6- nc	13- Nc	20- Nc
7- GND	14- Nc	21- GND

All dimensions are in mm

It is strongly recommended to ground all pins marked "GND" through the PCB board. Ensure that the PCB board is designed to provide the best possible ground to the package.

(1) The package outline drawing included in this data-sheet is given for indication. Refer to the application note AN0024 (<https://www.ums-rf.com>) for exact package dimensions.

Definition of the Sij reference planes

The reference planes used for Sij measurements given above are symmetrical from the symmetrical axis of the package (see drawing beside). The input and output reference planes are located at 3.39mm offset (input wise and output wise respectively) from this axis. Then, the given Sij parameters incorporate the land pattern of the evaluation motherboard recommended in paragraph "Evaluation board description".

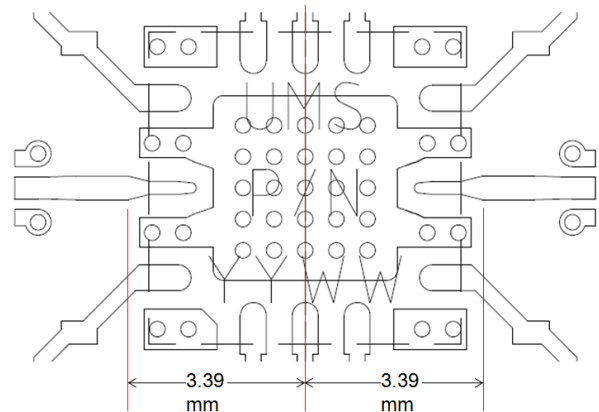

Package Information

Parameter	Value
Package body material	RoHS-compliant
Lead finish	Gold
Hermetic sealing (fine leak compliant Mil-Std-883 Method 1014.10 Condition A4, tracer gas He at 1atm)	1×10^{-8} ccHe/s/atm

Evaluation board description

- Compatible with the proposed footprint.
- Based on typically Ro4003 / 8mils or equivalent.
- Using a micro-strip to coplanar transition to access the package.
- Recommended for the implementation of this product on a module board.

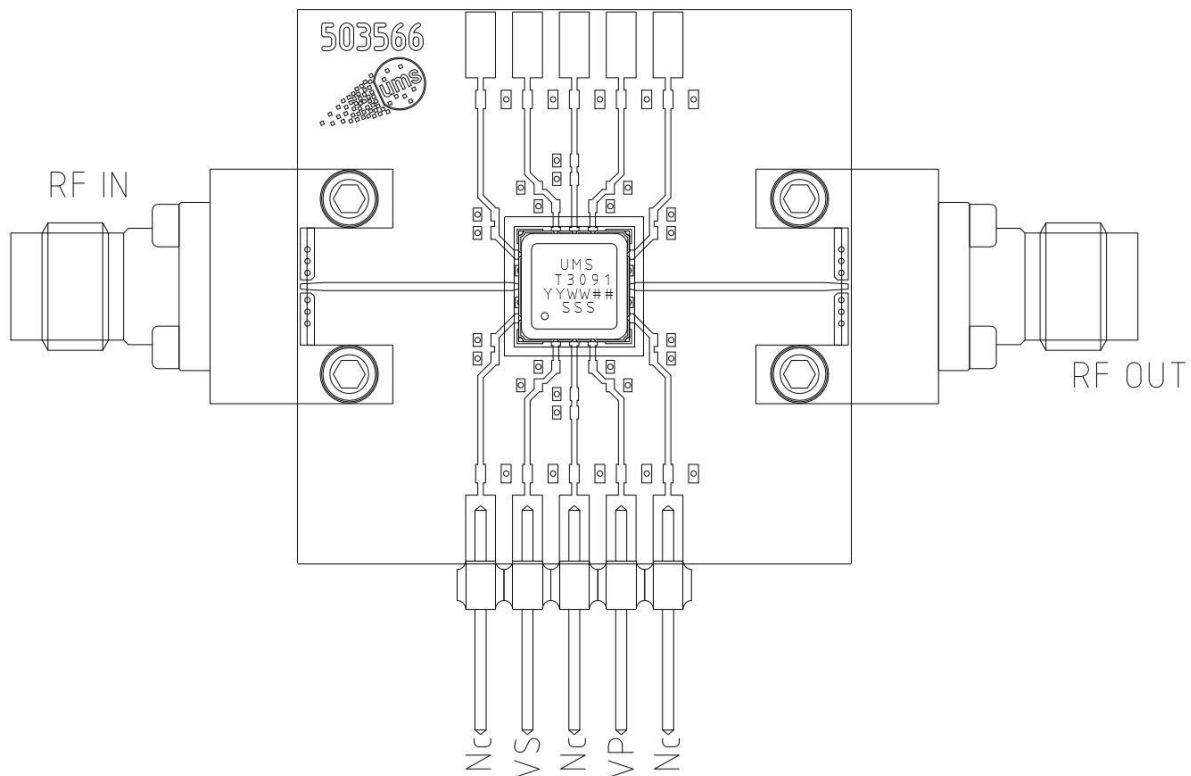

Note: All board measurements are performed using shielded cables, even for DC bias, to ensure safe operation.

Block Diagram

Block diagram of the circuit

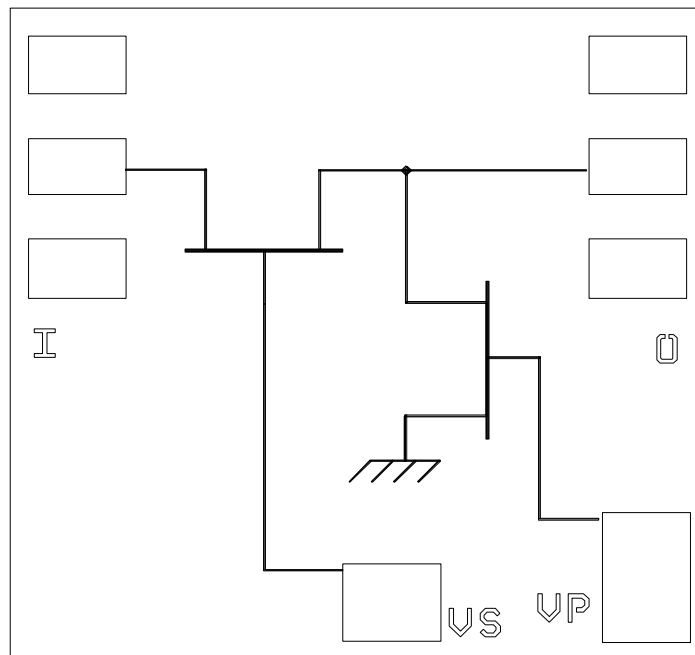

SMD mounting procedure

For the mounting process standard techniques involving solder paste and a suitable reflow process can be used. For further details, see application note AN0017 available at <https://www.ums-rf.com>.

Recommended environmental management

UMS products are compliant with the regulation in particular with the directives RoHS N°2011/65 and REACH N°1907/2006. More environmental data are available in the application note AN0019 also available at <https://www.ums-rf.com>.

Recommended ESD management

Refer to the application note AN0020 available at <https://www.ums-rf.com> for ESD sensitivity and handling recommendations for the UMS package products.

FAB Type Surface Mount Hermetic Package

Refer to the application note AN0024 available at <https://www.ums-rf.com> for assembly recommendations for the UMS FAB package products.

Ordering Information

Leadless hermetic package:

CHT3091-FAB/XY

Waffle pack: XY = 24

Information furnished is believed to be accurate and reliable. However **United Monolithic Semiconductors S.A.S.** assumes no responsibility for the consequences of use of such information nor for any infringement of patents or other rights of third parties which may result from its use. No license is granted by implication or otherwise under any patent or patent rights of **United Monolithic Semiconductors S.A.S.**. Specifications mentioned in this publication are subject to change without notice. This publication supersedes and replaces all information previously supplied. **United Monolithic Semiconductors S.A.S.** products are not authorised for use as critical components in life support devices or systems without express written approval from **United Monolithic Semiconductors S.A.S.**